



[allanblock.com](http://allanblock.com)

## Installation Manual for the



## Allan Block® Fence System

[allanblock.com](http://allanblock.com)

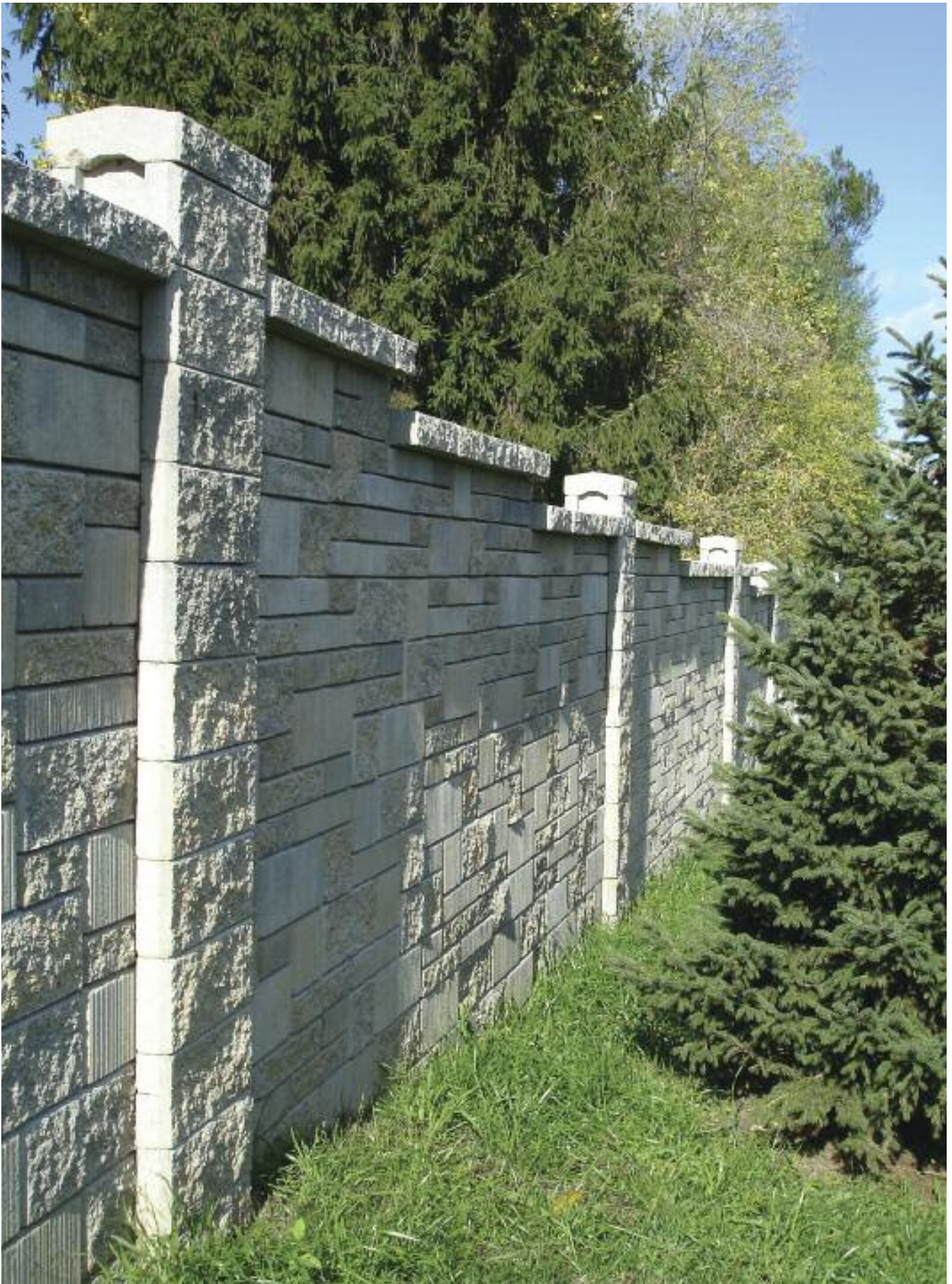

Visit [allanblock.com](http://allanblock.com) for more information

# Table of Contents

<b>System</b>	5
AB Fence System and Components	6
Applications	7
<b>Plan</b>	11
<b>Design</b>	15
Wind Speed	16
Wind Pressure	17
Engineering Methodology	17
Seismic	19
Design the Layout	20
Curves / Corners	21
<b>Build</b>	23
Jig Construction	24
Layout Construction	26
Pile Construction	28
Post and Panel Construction	29
AB Ashlar Fence Panel Construction	33
<b>Construction Details</b>	37
Step Ups and Step Downs	38
Gates and Accent Railings	38
Curves	39
Entryways	39
Lighting	39
Corners and Miter Cutting Post Blocks	40
Top of Fence Options	41
Water Management	42
Compaction and Tools	43
AB Fence Typical and Patterned Sections	44
Building a Bond Beam	46
<b>Specifications / Testing</b>	49
<b>Estimating / Design Tables</b>	55
Construction and Inspection Checklist	56
Design and Estimating Guide	58
<b>Charts</b>	
Typical Transmission Loss by Material	7
AB Pressure Coefficients (Ce)	17
Post Spacing Options	20
AB Fence Minimum Radius Chart	39
Pile Depth and Maximim Post Spacing	58
AB Fence Panel Block Quantity	58
Design Tables	60



allanblock.com

## AB Fence® by Allan Block

AB Fence® is a mortarless concrete block fencing system that uses maintenance free interlocking blocks to create an attractive and effective solution for sound abatement, security, privacy and more. With a clean, crisp architectural look, AB Fence is sure to be the product of choice.

The AB Fence Blocks lock together to create posts and panel sections that are versatile and stack up quickly for easy installation, which saves you time and money. The system can incorporate curves and corners with ease and use different colored/textured or multiple shaped blocks to create beautiful patterned fences.

Check out all the available options for AB Fence in this complete plan, design and build installation manual, or visit our website at [allanblock.com](http://allanblock.com) for the most up to date information.





## Who is Allan Block®

Allan Block has been helping construction and design professionals build better projects using our wide range of products for many years.

We offer expert training for all of our products and services to help ensure proper techniques are used and quality projects are built. By attending our training events you can become more efficient and confident, and increase your creativity on every job.

Visit [allanblock.com](http://allanblock.com) to see how you can become an AB Certified Contractor today.





[allanblock.com](http://allanblock.com)

## Quality Products

AB Fence combines the time proven performance of reinforced concrete with the benefits of mortarless technology to create a permanent solution for your projects needs.



Visit [allanblock.com](http://allanblock.com) for more information

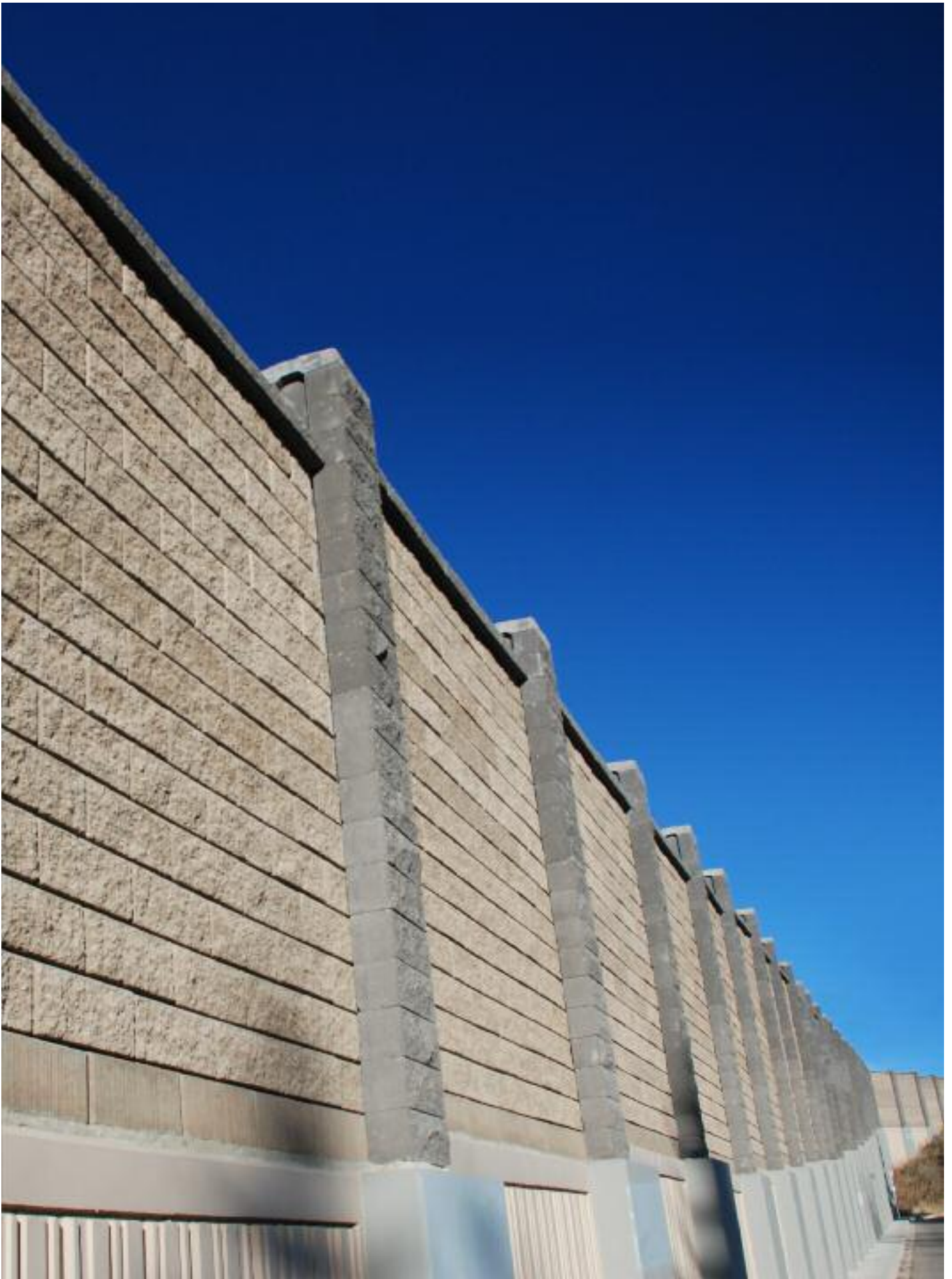

# SYSTEM



[allanblock.com](http://allanblock.com)

# AB Fence® System

The AB Fence System uses posts and panels like many typical fence systems to construct beautiful and durable concrete structures that will stand the test of time. The architectural look of the AB Fence evokes the feeling of stability and quality while also providing privacy, security and sound abatement, making the AB Fence System the product of choice.

The AB Fence Blocks have a split-faced look on one side and striated look on the other side. This gives the AB Fence System the ability to offer many different looks and styles without having to order any special blocks. Incorporating different color blocks to form patterns or banding within the panels and posts allows for even more options.



## Main Components

The three main structural components are the AB Fence Post Block, the AB Fence Panel Block and the AB Fence Cap Block.

The AB Fence Lite Panel and AB Fence Half Panel Blocks can be used along with the AB Fence Panel Block to create Ashlar Blend patterned panels. Together they provide the ability to design and create a fence that meets the requirements of each individual project.



**AB Fence Post Block**  
 8 in. H (200 mm)  
 12 in. W (305 mm)  
 18 in. L (460 mm)  
 70 lbs (35 kg)



**AB Fence Panel Block**  
 8 in. H (200 mm)  
 6 in. W (150 mm)  
 18 in. L (460 mm)  
 50 lbs (25 kg)



**AB Fence Cap Block**  
 5 in. H (130 mm)  
 12 in. W (305 mm)  
 18 in. L (460 mm)  
 60 lbs (30 kg)

## Components for Patterned Panels and Corners



**AB Fence Lite Panel Block**  
 4 in. H (100 mm)  
 6 in. W (150 mm)  
 18 in. L (460 mm)  
 25 lbs (10 kg)



**AB Fence Half Panel Block**  
 8 in. H (200 mm)  
 6 in. W (150 mm)  
 9 in. L (230 mm)  
 25 lbs (10 kg)



**AB Fence Corner Block**  
 8 in. H (200 mm)  
 12 in. W (305 mm)  
 12 in. L (305 mm)  
 50 lbs (25 kg)



**AB Fence Half Lite Panel Block**  
 4 in. H (100 mm)  
 6 in. W (150 mm)  
 9 in. L (230 mm)  
 13 lbs (5 kg)

## Component for Tall Projects



**AB Fence Large Post Block**  
 8 in. H (200 mm)  
 20 in. W (510 mm)  
 18 in. L (460 mm)  
 120 lbs (54 kg)

All specifications are approximate. Contact your local AB representative for exact dimensions and weights.

# Applications

## Sound Barriers

AB Fence provides the superior noise abatement, aesthetic style, durability and low maintenance of concrete masonry without the prohibitive costs associated with mortared masonry construction.

Sound barriers are solid obstructions built between the noise source and the receiver. An effective barrier will disperse sound along three paths: diffracted, reflected and transmitted. **Diffracted Noise (bent)** over the top of the wall produces a "shadow zone" behind the barrier, which is a function of wall height and the distances between the source, the barrier, and the receiver. **Reflected Noise** is directed away from the receiver. **Transmitted Noise** through the wall is a characteristic of the barrier material, determined by weight and stiffness and can be compared on the basis of transmission loss. The table shows that transmission loss by dense materials is most effective at stopping noise.



allanblock.com

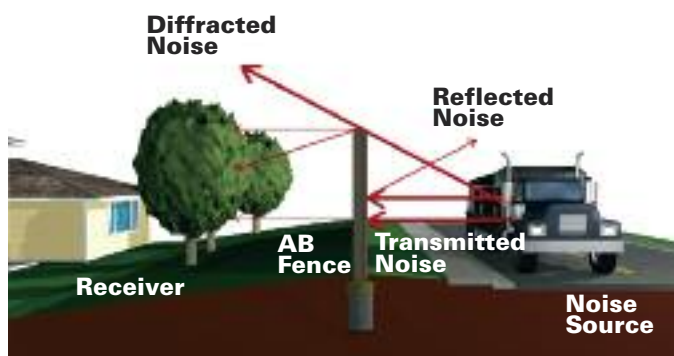

### Typical Transmission Loss by Material

Material	Thickness Inches (mm)	Surface Area Weight lbs/ft <sup>2</sup> (kg/m <sup>2</sup> )	Transmission Loss, dB
<b>AB Fence®</b> Concrete Block	5.6 (142.2)	36 (175.8)	32
<b>Concrete</b>	Light Weight	4.0 (101.6)	36
		6.0 (152.4)	39
	Sand-Gravel	4.0 (101.6)	48 (234.4)
<b>Masonry</b>	Concrete Block	3.6 (91.4)	22 (107.4)
		5.6 (142.2)	33 (161.1)
	Clay Brick	3.6 (91.4)	36 (175.8)
		5.6 (142.2)	56 (273.4)
<b>Wood</b>	Pine	0.5 (12.7)	1.5 (7.3)
		2.0 (50.8)	6.2 (30.3)
	Redwood	0.5 (12.7)	1.1 (5.4)
		2.0 (50.8)	4.3 (21.0)
	Cedar	0.5 (12.7)	1.1 (5.4)
		2.0 (50.8)	4.3 (21.0)
<b>Metal</b>	Aluminum	0.06 (1.5)	0.9 (4.4)
		0.25 (6.4)	3.6 (17.6)
	Steel	0.03 (0.8)	1.3 (6.4)
		0.06 (1.5)	2.6 (12.7)

## Beautification

The durability and aesthetics of the AB Fence make it an ideal solution for enhancing curb appeal. Use it alone or combine it with other fencing products to add elegance, beauty and increase privacy to perimeters and entrances. It allows you to create Ashlar Blend patterns into the fence panels with block sizes, textures or colors, develop flowing curves, and adjust for the grade changes of your site. The framed look created by the beveled edges of the AB Fence block give the product a distinctive clean look.





allanblock.com

## Screening and Containment

Communities are becoming more conscious of the relationship and proximity between commercial centers and surrounding neighborhoods. The AB Fence offers a cost effective and attractive means to separate residential areas from the noise of industrial and commercial areas. It can also be used to meet the screening and containment requirements in commercial development.





# PLAN



[allanblock.com](http://allanblock.com)

# Plan Before You Build

This installation manual provides overall guidelines to professional contractors for proper installation of the AB Fence System. All commercial and large-scale residential projects using the AB Fence require engineering provided by a qualified local engineer. While this manual provides general guidelines, the actual construction drawings provided by a local engineer should be referred to for final requirements and specifications.



A detailed site plan drawn to scale will help foresee design and construction challenges and provide an accurate reference for estimating.

## All Projects Start With a Plan

Before construction starts there must be a well thought out plan. Planning ahead will always save time and money in the end. The first thing to consider is what is the primary purpose or scope of the finished AB Fence? Is it a short seating wall, security wall, tall sound wall or something in between? Although the construction of the AB Fence is similar in all types of projects, the varied scope of a project may require a different level of planning.

## Before Starting Construction

Once the project scope is set and understood, here are a few things to consider in the planning stage:

- ***Where will the AB Fence to be located?*** Review the site to determine if the AB Fence System can accommodate the fence layout. Odd shaped angles and sharp curves in the layout may need to be redesigned or mitering of the post block will be required.
- ***Are there any utilities on the site?*** Utilities are any wires, pipes, cables or structures located below the ground surface. The presence of utilities are not necessarily a problem but they need to be located and clearly marked so they are not disturbed during construction. All states and provinces have "Call Before You Dig" hotlines that must be notified before any on site work begins.
- ***Are there water management issues currently on the site or will there be some after the project is complete?*** Having knowledge of the current sites drainage will allow the designer to correct and plan for any water issues during final design and construction. Openings in the AB Fence Panel can be installed to allow water to flow through the fence when required.





allanblock.com

- **What are the local code and permitting requirements?** Are there local height restrictions? How tall can the fence be before an engineered design, permit or even a variance is required? Are there setback requirements from the property lines? If an engineered design is required, what is the required wind pressure used for design?
- **Is a permit required?** It should be determined ahead of time what the city or municipality will require for the project approval process. In some cities, the approval process can take a long time to complete so the earlier the plan is submitted the sooner the project can begin.
- **Confirm the on-site soils.** The AB Fence pile footings rely on the soil to provide stability. If the site has soft, wet soils, or if the area was previously excavated, the foundation's soil may need to be replaced with good material and firmly compacted. Building in poor soils can cause footing instability and future settlements. Work with a local engineer to confirm the soil conditions and footing designs.
- **Will the required concrete be delivered from a ready-mix plant or mixed on-site?** Be sure to plan for truck access or site space for the mixing equipment.
- **Is there adequate access to the site for construction equipment and material storage?** Poor access could require smaller equipment or even hand work to complete the project. Material storage is often overlooked. Having a plan for how much material is delivered at a given time and where it will be placed will provide a safer work environment and ultimately save time and money with a more efficient worksite.
- **Consider the local weather in the plan.** What time of year will construction take place? Will cold weather building techniques need to be used or is it the rainy season? There should be a plan in place for weather related issues.
- **Confirm Inspection and Testing Requirements.** Depending on the design and local codes the project may require field inspection and testing to verify proper construction. Soil compaction tests along with concrete tests may need to be done by a third-party testing company.



## Safety

Follow the guidelines for worker and job safety established by your local Health and Safety Organizations. Take special precautions for OSHA or CCOHS requirements, which include excavation and scaffolding. Material Safety Data Sheets (MSDS) for materials used in construction of the AB Fences are available from the local manufacturer.

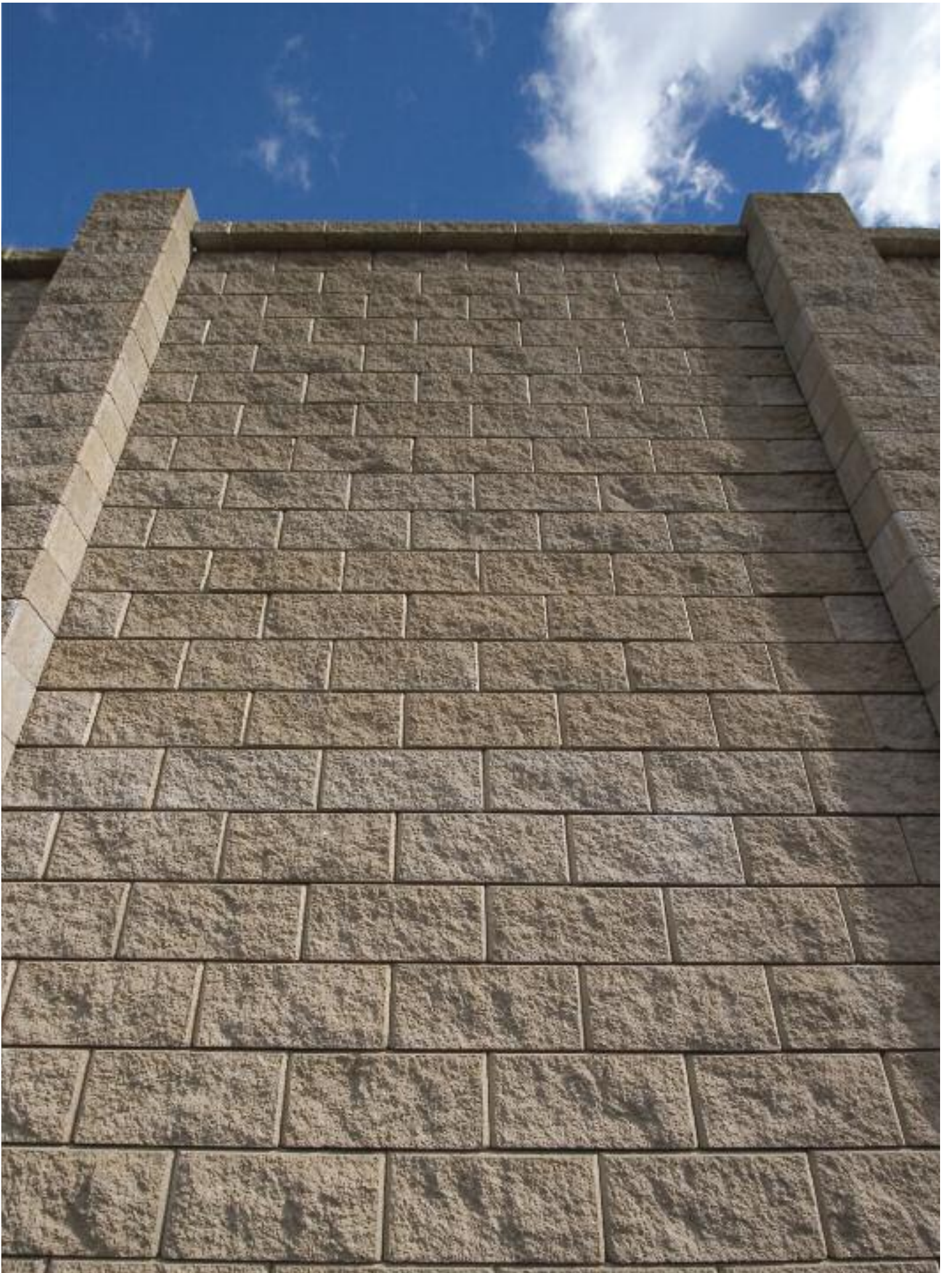

# DESIGN



[allanblock.com](http://allanblock.com)

# Design with AB Fence®

## Where to Begin?

The first things to consider when designing an AB Fence is what is the desired maximum height and what are the wind pressures the fence needs to resist. The resulting design will provide the maximum post spacing for the project. Once the maximum post spacing is determined, it can be used to optimize the plan layout provided by the site designer.

The strength of the AB Fence systems is its ability of resist wind loads. These wind loads are determined based on the average wind speeds in the project area and the exposure characteristics of the surrounding area. Average wind speeds will depend on where the project is and what the local weather conditions are.



## Wind Speeds

Wind is one of the significant forces of nature and must be considered in the design of the AB Fence System. For years meteorologist have accurately measured and recorded wind speeds. By analyzing this data the average wind speed for a given return period can be obtained for a region. The **return period** refers to the most probable average wind speed that will be equaled or exceeded once during a period of time compared to the life of the fence. The shorter the period of time the less the wind speeds. For example, a 10-year average wind speed will be much less than a 50-year average. Allan Block uses a 50 year return period for the AB Fence Design Methodology used in this manual.

See the Design Tables in the back of this manual to see examples of the design criteria for AB Fence projects.





allanblock.com

## Wind Pressures

Since wind is air in motion the resulting wind pressures are related to its kinetic energy and can be determined by the following standard expression:

$$q = \frac{1}{2} \rho V^2 \quad \text{where,} \quad \begin{array}{l} q \text{ is pressure in lb/ft}^2 \text{ or N/m}^2 \text{ (pascal)} \\ \rho \text{ is an average air density - 0.0809 lb/ft}^3 \text{ or 1.29 kg/m}^3 \\ \text{and V is the average wind speed in ft/sec or m/sec} \end{array}$$

This is called the **stagnation pressure** (q) because it refers to the maximum positive increase over ambient pressure that can be exerted on the fence by any given wind speed. Stagnation pressure is the basic, nonfactored pressure to which all other pressures are referred to and are usually referenced in regional building codes.

Wind pressures exerted on the AB Fence depend not only on the speed of the wind, but on the interaction of exposure effects as well. Structures such as buildings, landscape features, street corridors and open areas such as fields, parks, parking lots and bodies of water all significantly affect the wind patterns and need to be considered. An **exposure category** that adequately reflects the characteristics of ground surface irregularities is determined for the site. Open terrain allows for the maximum exposure, while structures found in developed or urban areas have minimum exposure.

## Exposure

Described below are the three exposure categories used in the designs of the AB Fence:

- **Exposure B:**  
Urban and suburban areas, wooded areas, or other terrain with numerous closely spaced obstructions having the size of a single family dwelling or larger.
- **Exposure C:**  
Open terrain that includes flat open country, grasslands, and bodies of water under 1 mile (1.6 km) in width.
- **Exposure D:**  
The most severe exposure with flat, unobstructed areas and bodies of water over 1 mile (1.6 km) in width. Exposure D extends inland from the shoreline ¼-mile (0.4 km).

## Engineering Methodology

Design calculations have also included site topography and structural importance when factoring wind pressures on a structure. The table shown here provides the AB Pressure Coefficients. The coefficients are listed by the exposure category, but are based on general site topography, structure height and structural importance as well.

For the AB Fence designs, the wind pressure is based on the 50-year average wind speed (return period) and should be multiplied by the appropriate pressure coefficient. This factored pressure is then used in the design calculations, which is based on simple beam theory and basic engineering principles.

<b>AB Pressure Coefficients (Ce)</b>		
<b>Exposure</b>	<b>H&lt;12 ft (3.7m) Pressure Coefficient</b>	<b>H&gt;12 ft (3.7m) Pressure Coefficient</b>
<b>B</b>	<b>0.68</b>	<b>0.85</b>
<b>C</b>	<b>0.9</b>	<b>1.2</b>
<b>D</b>	<b>1.2</b>	<b>1.5</b>

## Example

This example shows typical design calculations for the AB Fence. For definitions of variables, see the AB Fence Engineering Manual for terminology at allanblock.com.

Analyze an AB Fence with the following characteristics:

Fence Height:  $H = 6 \text{ ft (1.83 m)} = 9 \text{ courses}$

Soil Type: *Clay SD* = 100 psf (4.8 kN/m<sup>2</sup>)

Pressure Coefficient ( $C_e$ ): 0.68

Wind Speed:  $V = 80 \text{ mph (35.8 m/s)}$

Exposure Type: B

Based on this information, we can perform the calculations for pile dimensions as follows:

Assume Post Spacing:

$P_s = 18.2 \text{ ft (5.55 m)} = 11.5 \text{ panel block}$

Assume values for pile dimensions:

Where:  $SD$  = Lateral bearing capacity of soil

$SD = 100 \text{ psf (4.8 kN/m}^2\text{)}$

Bond Beams:

$N_{bb} = 2 - \#4 \text{ bars}$

# Bars in post: 4 - #5 bars

Assumed Pile depth:  $d = 4 \text{ ft (1.2 m)}$

Assumed Pile diameter:  $b = 2 \text{ ft (0.61 m)}$

$S_{factored} = 2/3(SD) = 66.7 \text{ psf (3.2 kN/m}^2\text{)}$

Calculate the wind pressure:

$q_s = 1/2 p(V^2) = 0.00256(V^2) = 16.4 \text{ psf (785.2 N/m}^2\text{)}$

Calculate the tributary area:

$T_a = P_s(H) = 110.5 \text{ sq. ft (10.3 m}^2\text{)}$

Total load applied from wind factor:

$P = (q_s)(C_e) = 11.15 \text{ psf (534 N/m}^2\text{)}$

Start by assuming a pile diameter and depth. Use the following equations to find actual pile size:

Where:  $H_p$  = The distance from the ground surface to the point of load application.

$$\text{Pile Depth} = \left( \frac{A_p}{2} \right) \left[ 1 + \sqrt{1 + \frac{(4.36)(H_p/2)}{A_p}} \right] \quad \text{where: } A_p = \frac{(2.3)(P)(T_a)}{(S_{factored})(d)(b)} = 5.4 \text{ ft (1.65 m)}$$

Continue the above calculation, changing your values for b and d, until the calculated pile depth is greater than the assumed pile depth. After iterative calculations a pile depth of 4.5 ft (1.37 m) and a pile width of 2.0 ft (0.61 m) will be sufficient for this application. Allan Block recommends a 2.0 ft (0.61 m) minimum pile diameter be used.

### Design Moments:

$$\text{Post: } M_{postd} = \frac{(P)(T_a)(H)}{2} = 3,742 \text{ lb-ft (5,073.5 N-m)}$$

$$\text{Panel: } M_{paneld} = \frac{(P)(P_s^2)(H)}{8(N_{bb})} = 1,400 \text{ lb-ft (1,898.1 N-m)}$$

### Compressive Stress Moments Capacity:

$$\text{Post: } M_{cp} = \frac{(f_b)(b_s)(d_s^2)(j)(k)}{2} = 15,752 \text{ lb-ft (21,365.8 N-m)}$$

$$\text{Panel: } M_{cbb} = \frac{(f_b)(b_{bb})(d_{bb}^2)(j_{bb})(k_{bb})}{2} = 1,974 \text{ lb-ft (2,676.4 N-m)}$$

**Tributary Area Per Post**

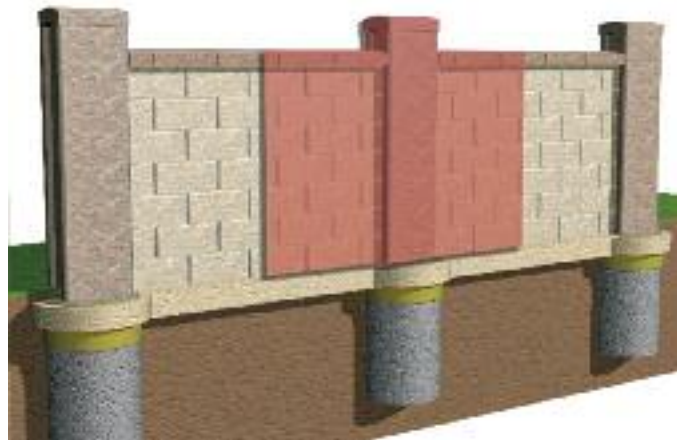



allanblock.com

**Tensile Stress Moments Capacity:**

Post:  $M_{tp} = f_s \left( \frac{A_s}{2} \right) (j)(d_s) = 12,888 \text{ lb-ft (17,473.8 N-m)}$

Panel:  $M_{tbb} = (f_s)(A_{bb})(j_{bb})(d_{bb}) = 1,497 \text{ lb-ft (2,027.7 N-m)}$

**Shear Stress:**

Allowable shear stress in masonry is equal to the square root of the uniaxial compressive strength of the masonry  $S_{ssa} = 7,929 \text{ psf (379 kN/m}^2\text{)}$ .

The calculated shear stress at the base of the post and post wing:

**Post:**

$S_{req} = \frac{P(T_a)}{b_s(d_s)} = 1,504 \text{ psf (72.0 kN/m}^2\text{)}$

**Post Wing:**

$Swing = \frac{2,779 \text{ lb}}{3 (h)} = 1,457 \text{ lb/ft (21.27 kN/m)}$

Where: h = block height

2,779 lb/block was determined by independent testing.

The calculated shear is as follows:

**Panel Area:**

$a_{npanel} = H (P_s - 1.469 \text{ ft.})$

$Sw_{req} = \frac{0.5(a_{npanel})(P)}{H} = 93 \text{ lb/ft (1,352 N/m)}$

Make sure that all design values exceed the design criteria, by verifying the following:

$M_{postd} < M_{cp}$                        $M_{paneld} < M_{cbb}$                        $M_{postd} < M_{tp}$   
 $M_{paneld} < M_{tbb}$                        $Sw_{req} < Swing$                        $S_{req} < S_{ssa}$

Note: For complete engineering details please contact the Allan Block Engineering Department at 800-899-5309 or visit allanblock.com.

See the AB Fence Engineering Manual for terminology at allanblock.com.

**Seismic**

Another potential loading condition is seismic. In all relative building codes the effects from seismic and the effect from wind are never combined. This means that for seismic to control the design, its effects must be greater than those of wind. Wind is a nearly constant variable that makes it much more critical than seismic events that are vary localized. Therefore, this manual will concentrate on the effects of wind. For seismic loadings, refer to your local building codes.

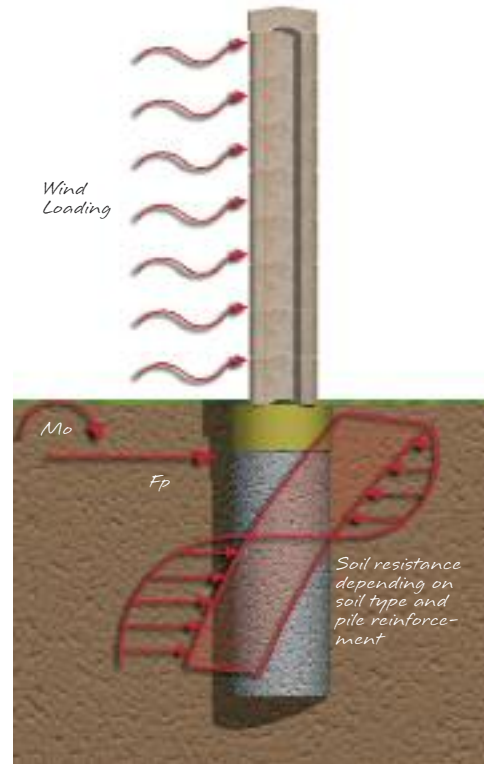

# Design the Layout

The AB Fence System is similar to a traditional wooden fence in that the panels are supported by the posts. The posts are anchored in place with concrete below grade. Therefore, the final support to the AB Fence or the wooden fence is done by the soil around the pile footings.

The advantage of the AB Fence System when compared to other concrete systems is how the panels slide into the AB Fence posts, but are still allowed to move independently. This flexibility eliminates the requirement of constructing the panels below the local frost limits, which keeps the installation costs down.

Knowing the desired location of the fence is your starting point. For estimating purposes, use the Design Tables on page 60. Remember that the final design should come from a local engineer. Next, finalize the fence height and panel spacing. The AB Fence Posts must be placed at set locations to allow for the AB Fence Panel Blocks to fit between them properly without unnecessary cutting of blocks.

For the approximate post spacing and associated number of panel blocks, refer to the table below. To accommodate a project specific lengths, use a combination of two or three different post spacings. Using the shorter post spacing may not reduce the pile depth. Final pile locations will be determined during the installation process shown on page 26.



## Determining the Number of Panels

The best way to explain this is to work through an example. Our sample project will be 160 ft (49 m) long with a desired height of 8 ft (2.4 m) in clay soil.

Using the Design Charts on page 60 we determined:

- Exposure B with 80 mph (35.8 m/s) winds
- Maximum Post Spacing: 15.3 ft (4.7 m) or 9.5 blocks per panel

However with our project this would give us a total of 10.4 panels (160 ft divided by 15.3 ft), which is 10 panels with a span of 9.5 blocks and 1 panel with 4 blocks. This will work, but will not look completely uniform. An option may be to use 10 panels with a span of 9 blocks and one panel with a span of 9.5 blocks (see graphic above). See the table on the right for more post spacing options. If there will be corners in the project, each section will need to be figured independently, see page 40 for more information.

Post Spacing Options	
Number of Panel Block	Post Spacing Increments*
4	7.2 ft (2.2 m)
4.5	7.9 ft (2.4 m)
5	8.6 ft (2.6 m)
5.5	9.4 ft (2.9 m)
6	10.1 ft (3.1 m)
6.5	10.8 ft (3.3 m)
7	11.6 ft (3.5 m)
7.5	12.3 ft (3.8 m)
8	13.1 ft (4.0 m)
8.5	13.8 ft (4.2 m)
9	14.5 ft (4.4 m)
9.5	15.3 ft (4.7 m)
10	16.0 ft (4.9 m)
10.5	16.7 ft (5.1 m)
11	17.5 ft (5.3 m)

\*All post spacing measurements are approximate, check with your AB representative to verify block specifications and more information.

## Curves

The post and panel connection offers the flexibility to create fluid curves and radiuses unmatched by other fencing systems. The length of the panel and what type of connection, Standard or Modified, will determine the radius of the fence. See page 39 for construction details.

Other dramatic transitions can be achieved by mitering the post blocks to the desired angle. See the construction detail on page 40 for Cutting Post Block to Make a Corner.

## Corners

The AB Fence Corner Block makes the construction of a 90 degree corner easy. No special tools or cutting of blocks are required. When laying out the fence to include the corner and adjacent post locations, keep in mind the post spacing is slightly shorter than a panel without a corner post. This will eliminate cutting panel blocks later in the installation process. See page 40 for Construction Details.

## Grade Changes

The AB Fence system can be designed to accommodate grade differences on either side of the fence. Designing the lower portion to retain the soil and providing the benefits of the fence above can be completed with one system. The AB Fence system is used as a veneer facing to a geogrid reinforced soil mass complete with proper grading and water management.

Each course of the AB Fence that is involved in retaining soil should be constructed as a bond beam with horizontal steel and vertical stirrups. It is recommended that the entire fence be completely installed to the design height before backfilling and compacting the retained soil.



allanblock.com



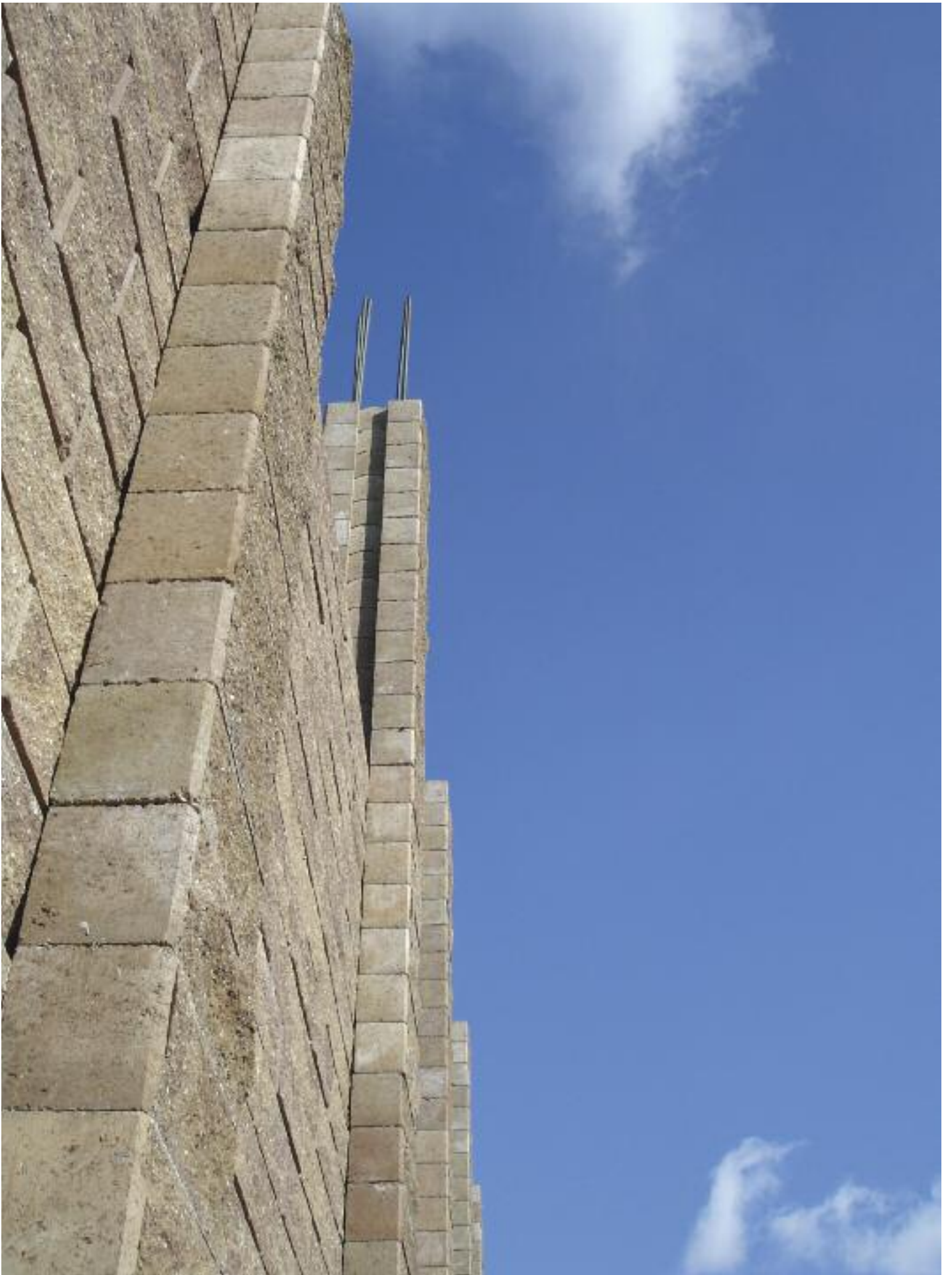

# BUILD



[allanblock.com](http://allanblock.com)

# AB Fence Construction - Jigs

AB Fence is designed to utilize the advantages of dry-stacked masonry. This mortarless technology provides an efficient and easy installation process.

Before you start building, put these simple tools together to make the job go much smoother.

## Pile Layout Jig

The pile layout jig (Figure 1) is used after the piles are poured, but not quite hardened to set the location of the post blocks on the piles and ensure the exact relative spacing between each AB Fence post. This will also indicate precisely where the rebar needs to be placed in the piles (Figure 2). The optional rebar alignment plate can be used for increased accuracy of bar placement, see Figure 3.

To ensure an accurate pile layout spacer, **line up the number of panel blocks you are using on a flat surface and measure the actual panel length nub to nub. Use this field-measured length to assist in pile spacing and in constructing the spacers in Figure 1 and 4.**

Using 2 x 6's construct two post block templates as shown in Figure 2. After measuring the exact panel length, nub to nub, cut a 2 x 6 to this length plus 0.5 in (13 mm) extra to account for the required space between panel block and post pocket. This 2 x 6 is the Pile Layout Spacer shown in Figure 1 and is used between the post block templates.



Figure 1: AB Fence Pile Layout Jig

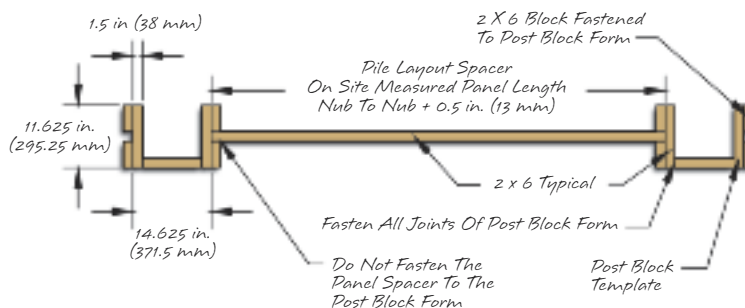

Top View of Panel Block

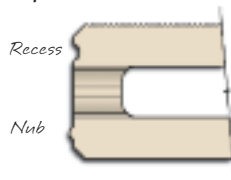

Figure 2: Post Block Template with Pile Steel Placement

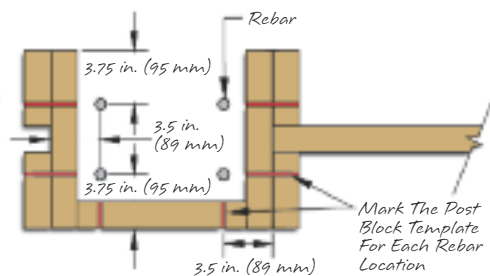
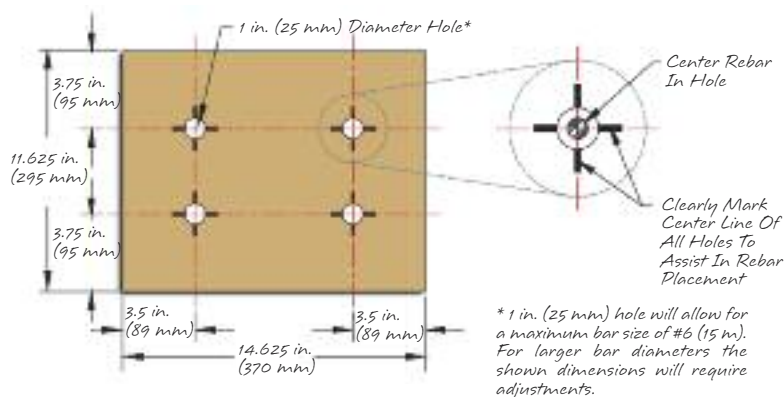

Figure 3: Optional Rebar Alignment Jig





allanblock.com

## Post Spacer

The 2 x 12 post spacer (Figure 4) is used to help keep the AB Fence Post Blocks square and aligned as the posts are positioned on the pile and as additional post blocks are being stacked.

Using a 2 x 12, notch the ends as shown in Figure 5 to slide into the end of the AB Post Block. This spacer will help you keep the post blocks from being turned or twisted out of alignment and relative to each adjacent post.

## Funnel

Using a funnel to help direct the grout into the block cores will allow for easier installation and keep the grout off the block face.

Assemble two 2 x 6's approx. 36 in. (915 mm) long for the side boards and two 15 in. (380 mm) long boards for each end as shown in Figure 6. Angle the side 2 x 6's to match the top surface of the panel block. Leaving a 2.5 in. (65 mm) opening for the grout to flow through. See Figure 6.

## Stirrup Jig

Vertical steel stirrups are used in the bond beams to give added stability to the bond beam structure.

To assist with the production of required stirrups, construct the stirrup jig as shown in Figure 7. A simple jig can be constructed using a wood base, two 1.5 in. (38 mm) dia. wood dowels and a set peg or screw. A stirrup is typically formed using 9 ga wire, and wrapped around the dowels to create an "S" shape. Making sure the final stirrup is at least 14 in. (355 mm) long for a two-course bond beam and 21 in. (533 mm) long for a three-course bond beam. See page 46 for additional information on bond beam construction.

Figure 4: Post Spacer Jig



Figure 5: Post Spacer End Detail

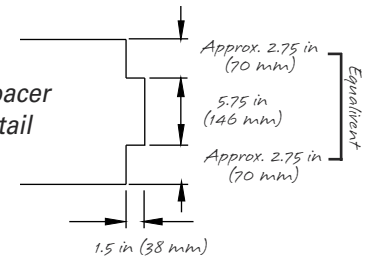

Figure 6: Funnel for Grout Placement

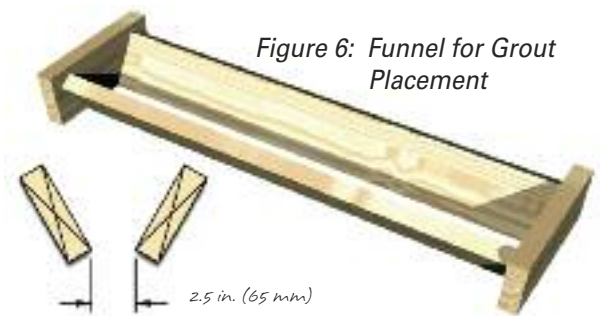

Figure 7: Stirrup Jig for Two-Course Bond Beam



# AB Fence Construction - Layout

## Step 1

- Review the approved construction design for post spacing and horizontal alignment.
- For layout procedures for the corner block, see page 40 for a construction detail or the AB FenceTech Sheet #2005 available at [allanblock.com](http://allanblock.com)
- Mark out the center of each pile per the requirements of the approved construction design. Suggested methods of doing this include: string line to establish the overall layout of your fence, a steel chain to develop precise duplicated spacing between posts, or by having the points set by a surveyor.
- Establish offsets to the center of the piles for later reference by using a substantial grade stake that is not easily displaced.
- Excavate a 6 in. (150 mm) deep by 12 in. (300 mm) wide trench the entire length of the fence. The centerline of the trench should also be the centerline of the AB Fence placement.
- Relocate post center locations using construction offsets and a string line.
- Excavate the pile holes to the depth and diameter specified in the approved construction design.
- When drilling the holes keep in mind that hole positioning is critical. A maximum allowable deviation of  $\pm 1$  in. (25 mm) for the pile cap is allowed for the horizontal locations. See Figure 8.
- When the pile holes are excavated each hole must be checked to make sure loose material is not at the bottom of the hole. Use a long handled hand tamper to compact this soil when necessary.
- Soils engineers will need to verify the bearing capacity at the bottom of the pile.
- Check with your local building officials to see if a site visit is required for pile inspection.

### Trench Dimensions

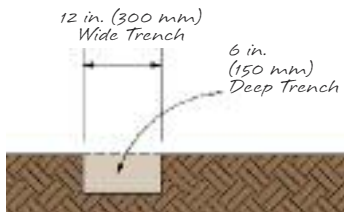

**Note:** The soil that the AB Fence is built on must be compacted and capable of supporting the weight of the structure.

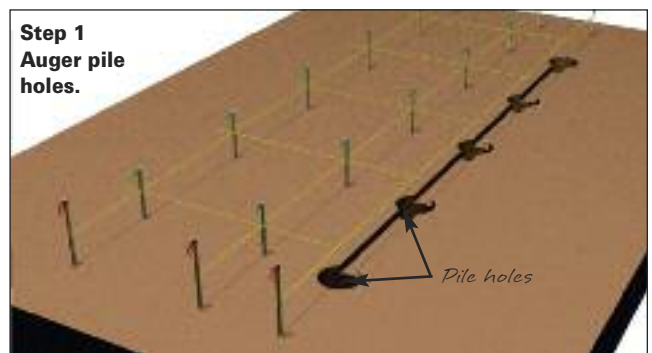
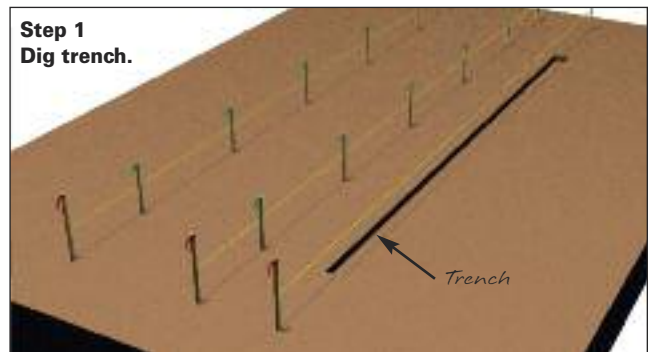
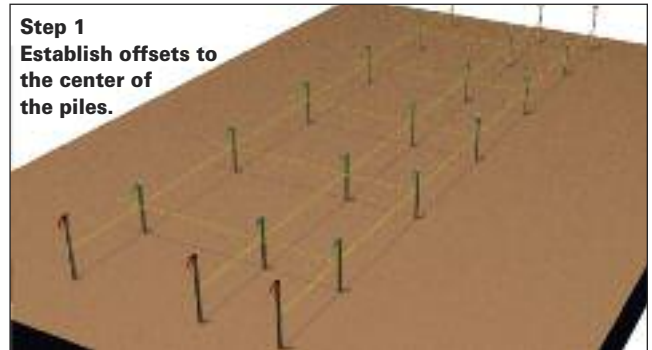
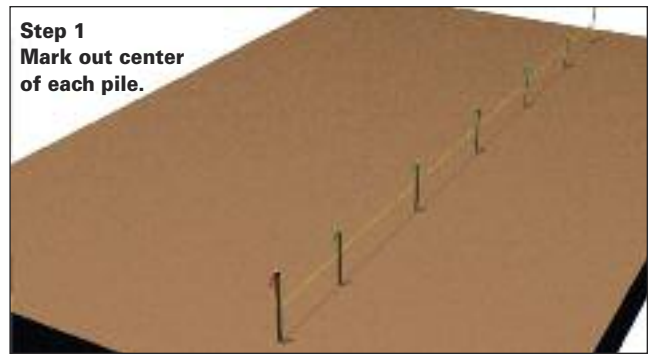

### Typical Pile Footing Excavation

#### Cohesive Soils

Standard concrete form  
12 in. (305 mm) depth.



#### Granular Soils

Extended concrete form  
depths.





allanblock.com

## Step 2

- Use a concrete form, or alternate cylindrical tubing material, to form the top of the pile hole to create a pile cap. The form should have the same inside diameter as the design pile diameter, and be a minimum of 12 in. (300 mm) deep. Additional length may be required if the sides of the excavation cave in, which is typical for granular soils.
- Place the concrete form in the hole, making sure that the center of the concrete form is in alignment with the centerline of the AB Fence to  $\pm 1$  in. (25 mm), see *Figure 8*.
- Using a laser level, transit or string level, set the top of the concrete form level with or no more than 1 in. (25 mm) below the design elevation of the top of the pile. Use hand levels to level each concrete form pile cap individually.
- The concrete form can either be braced against the sides of the hole or staked to maintain elevation and location during casting. For a cross section of the pile hole see *Figure 9*.

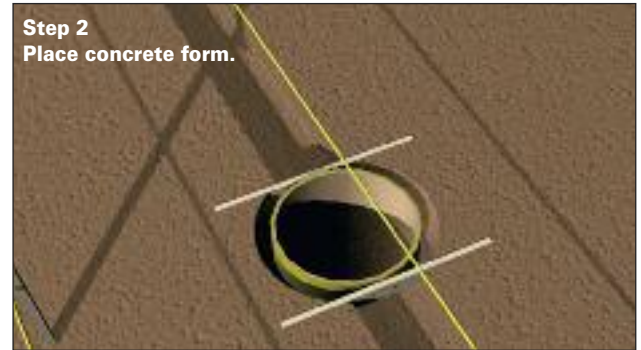

## Step 3

- To set the exact spacing between each AB Fence post, use the AB Fence Pile Layout Jig shown in *Figure 1*.
- Mark the placement of the rebar in the pile, using the Post Block Template similar to *Figure 2* during the pile pour. For more information see the construction detail on page 25.
- Spacing between each pile must be maintained to a tolerance of  $\pm 0.5$  in. (13 mm) to allow for proper interlock between post and panel sections.

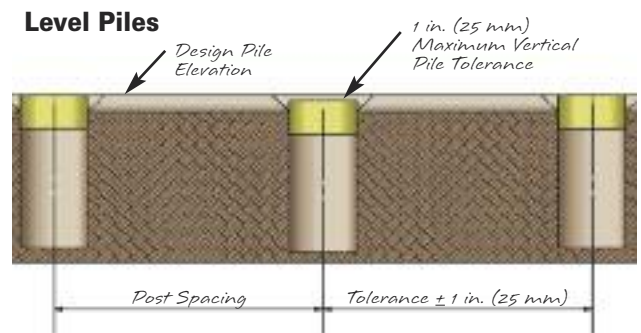

Figure 8: Pile Construction Tolerances

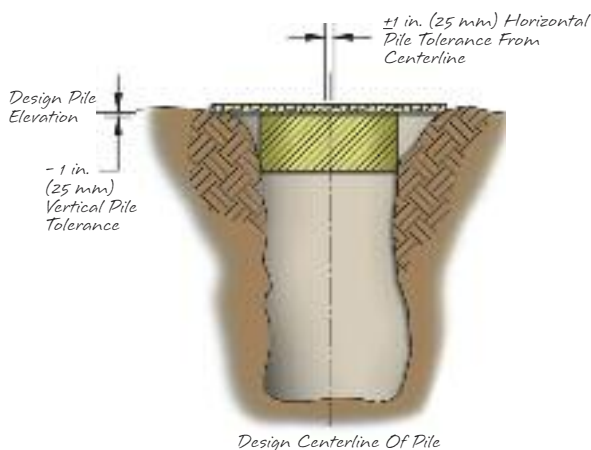
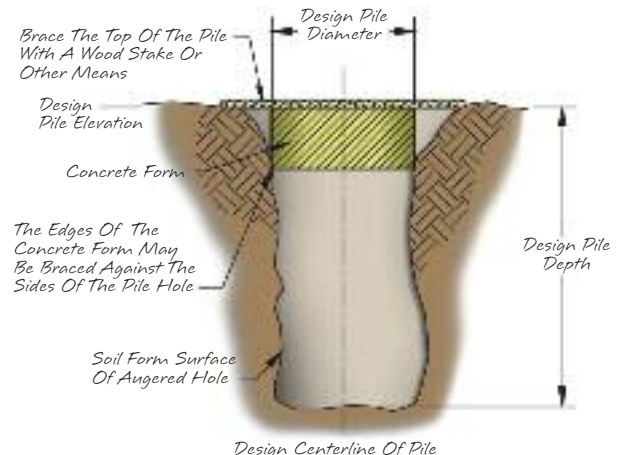

Figure 9: Pile Hole Cross Section



# AB Fence Construction - Piles

## Step 1

- Pour concrete meeting or exceeding the minimum strength requirements specified in the approved construction design into the pile holes.
- During the pour of each pile, ensure that the concrete form is braced to maintain the correct elevation and horizontal location. Double check with laser and hand levels to maintain tolerance; minor adjustments will have to be made during the pour. See *Figure 8*.

- Horizontal Tolerance:  $\pm 1.0$  in. (25 mm)
- Vertical Tolerance: -1.0 in. (25 mm)

- Finish concrete using a hand trowel or other equipment to create a flat surface for post placement.
- For mixing and placing concrete in cold weather see AB Fence Tech Sheet #2006 available at [allanblock.com](http://allanblock.com).

## Step 2

- Immediately following the concrete pour, relocate the center of the AB Fence post using the AB Fence Pile Layout Jig, shown in *Figure 1*, and make an impression in the wet concrete to mark it.
- Place the vertical steel reinforcement bars (rebar) using the placement template shown in *Figure 2*; or for greater accuracy use the optional rebar alignment jig shown in *Figure 3*. Pay close attention to make sure that the center of the template is at the center of the AB Fence post and square to the adjacent AB Fence post. This can be done using offsets and string lines.
- The rebar must be placed to  $\pm 0.5$  in. (13 mm) of the design's horizontal location. When placing rebar, a tolerance of  $\pm 0.5$  in. (13 mm) must be maintained to allow for proper interlock between post and panel sections.
- The rebar must extend into the pile to the depth specified in the approved construction design, but maintain a 3 in. (75 mm) clear cover at the bottom of the pile.
- The rebar should extend out of the top of the pile to a length equal to or greater than the minimum lap splice requirements set by the approved construction design or a minimum of 24 in. (610 mm).

## Step 3

- Before setting any AB Fence Post Blocks, allow the concrete to harden approximately four hours, or until hard enough to resist more than surface scratching when scraped with rebar.

**Note:** The AB Fence uses two different types of concrete during construction. The piles and AB Fence Post Blocks use concrete with gravel and sand size aggregate. This type of concrete is generally available from concrete plants and used in most types of construction. However, the bond beams require what is referred to as a fine mix concrete grout. This mixture of concrete uses only sand as the aggregate, which makes it ideal for filling the smaller cores of the AB Fence Panel Block.

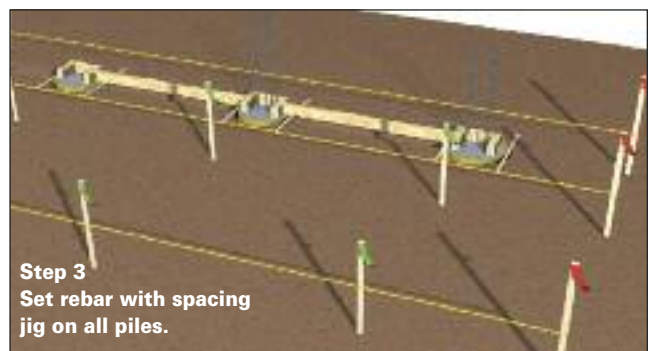
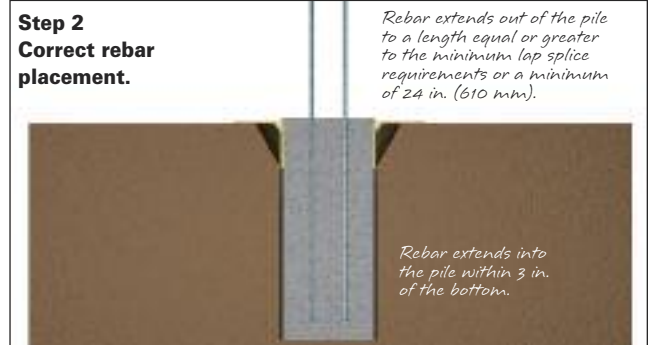
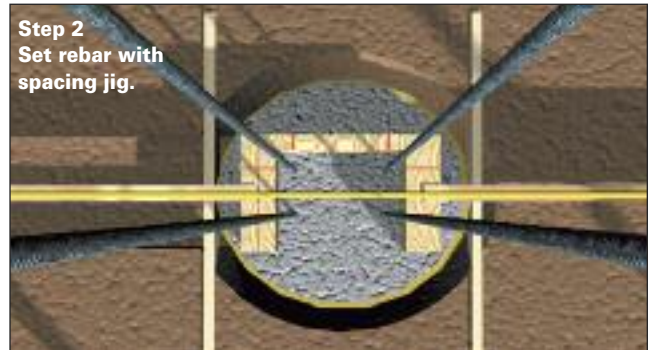
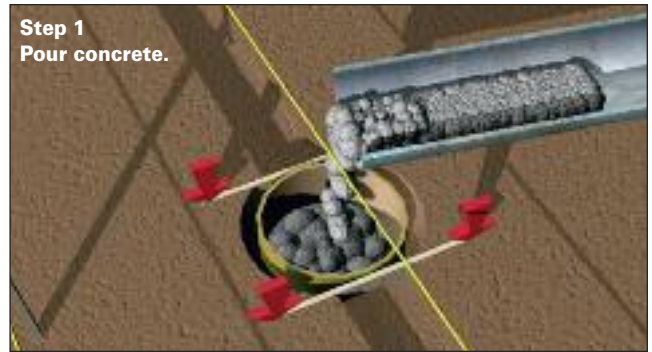

### Post and Rebar Placement

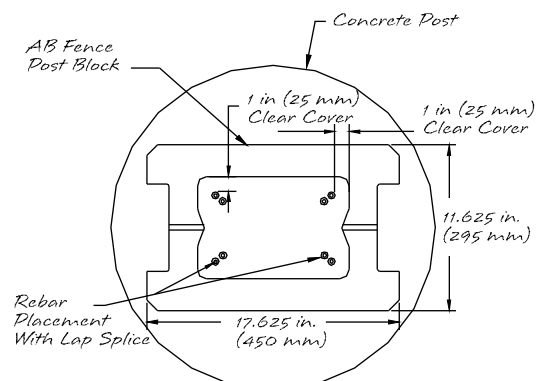

# AB Fence Construction - Post and Panels



allanblock.com

## Step 1

- Fill the trench between each hardened pile with 6 in. (152 mm) of well-graded, granular compactible aggregate. In place of the compacted aggregate base, an unreinforced concrete leveling pad can be used. If a concrete leveling pad is used, provide expansion material between the ends of the pad and the sides of the piles (see detail below).
- Screed the aggregate from pile to pile to create a level base for the panel.
- Use a mechanical plate compactor, or other acceptable means, to compact the aggregate.
- Check base for level using a hand level and screed. The base should be level with the piles.

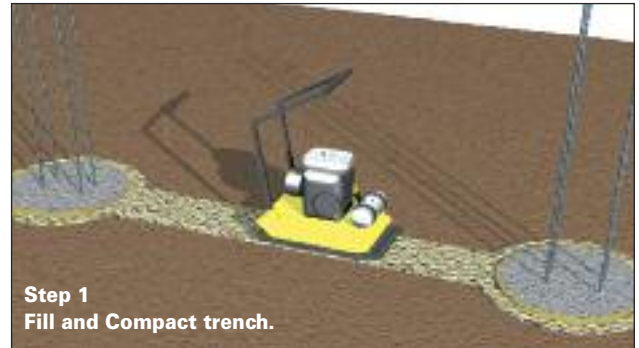

Step 1  
Fill and Compact trench.

## Step 2

- Using a laser level, check the elevation of each hardened post pile.
- Post blocks may be placed on a mortar bed, a maximum of 1.0 in. (25 mm) thick, to achieve consistent starting elevation.
- A mortar bed may be required during the installation of the first post block to achieve a consistent starting elevation. Mortar must be the same strength or greater than the concrete mix used to fill the post block.
- Set the first AB Fence Post Block on each pile and/or on a mortar bed.
- Check the post blocks for level in all directions, and in a straight line from pile to pile, using a string line for reference.
- Use the 2 x 12 post spacer shown in *Figure 4* to help keep the post blocks square and aligned. When errors in spacing occur on post layout, adjustments should be confined to the panel between the two incorrect posts.
- Check for proper elevation from one post to the next using a laser level or leveled string line.

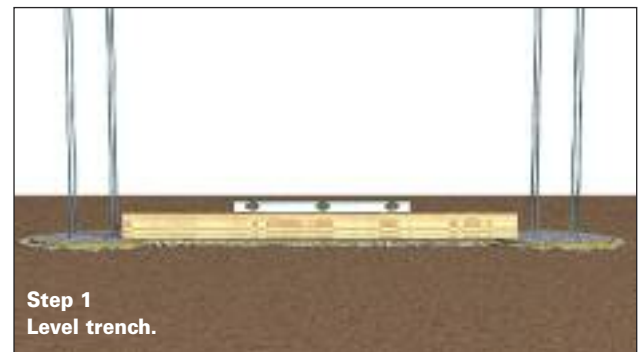

Step 1  
Level trench.

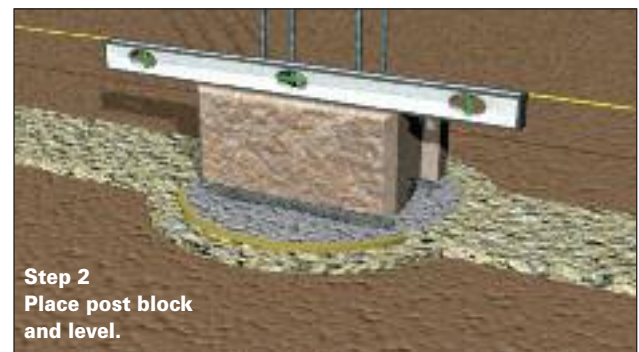

Step 2  
Place post block  
and level.

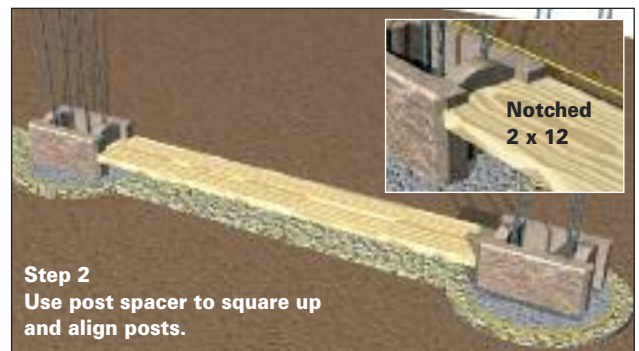

Step 2  
Use post spacer to square up  
and align posts.

### Optional Unreinforced Concrete Leveling Pad

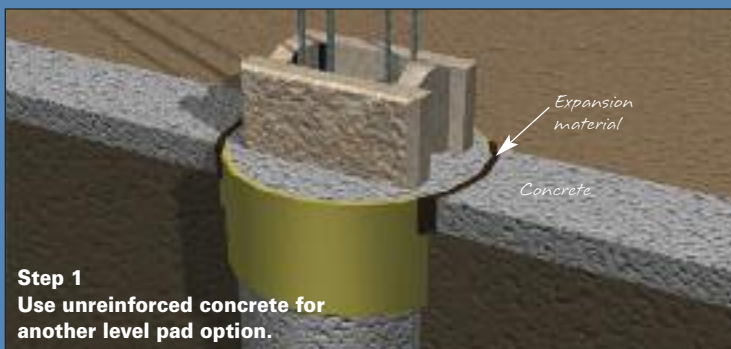

Step 1  
Use unreinforced concrete for  
another level pad option.

If a concrete leveling pad is used, provide expansion material between the ends of the pad and the sides of the piles.

### Step 3

- Once the first post block and mortar bed have hardened, stack a second post block on each post column.
- Check the post blocks for plumb; shim with asphalt shingles or other non-degradable material as necessary. Level in all directions.

**Note:** Wooden door shims work well for the posts because they can be removed when concrete has set.

- Place a course of AB Fence Panel Blocks from post to post on the compacted granular aggregate base to form the bottom course of the bottom bond beam. The blocks should be installed level in all directions and in a straight line from post to post. Move the string line to provide a point of reference. A total deviation of 0.125 in. (3 mm) is allowable. The panels must extend 1 in. (25 mm) minimum into each post.

#### Block Tolerance

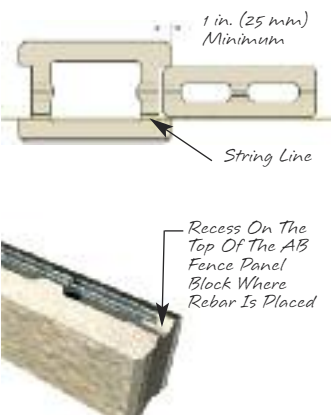

- Place a continuous piece of #4 (10M) rebar on the recess on the top of the first bond beam course.
- Rebar should be 3 in. (75 mm) shorter than entire panel section to allow for a 1.5 in (38 mm) clear cover at each end.

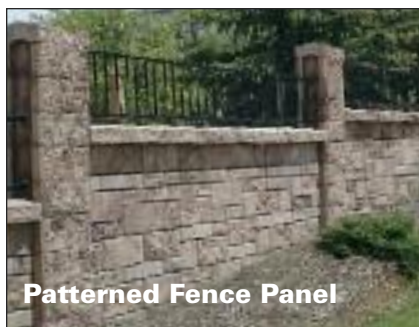

**Patterned Fence Panel**

**If building a patterned fence project, skip ahead to page 34 to finish Step 3.**

- Stack a second bond beam course of panel blocks. By sliding the blocks into place will remove any excess slag material. The panel blocks should be stacked so that the vertical seams align with the midpoint of the block on the course below in a "running bond pattern." A half panel block will be required at the ends of the panel on alternate courses. If a manufactured AB Fence Half Panel Block is not available, an AB Fence Panel Block must be cut in half to obtain a half panel block using a concrete saw with a diamond blade.
- Check the first two courses of panel block for alignment and plumb. Shim and adjust as necessary.

**Note:** When cutting blocks refer to the appropriate MSDS sheets and wear proper safety gear.

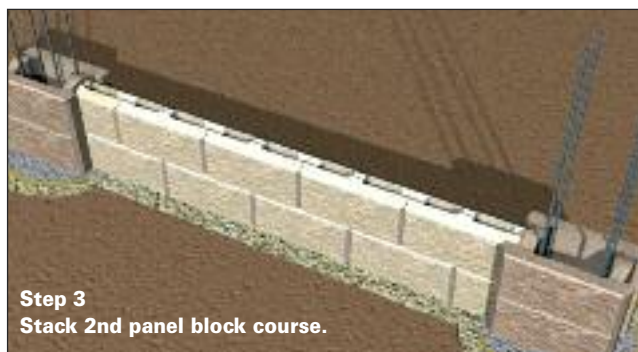



allanblock.com

### Step 4

- Fill the cores of the first two courses of panel blocks (bond beam) with fine (sand) mix concrete grout. Using a funnel, similar to the one shown at the right, allows for easy installation and keeps the grout off the face of the panel block. See page 25 for information on constructing a funnel.
- As the cores are filled, place 9 ga vertical steel stirrups in the first two block cores at both ends and then in alternating block cores for the rest of the panel, making sure to meet the one per block minimum requirement. See page 25 and 47 for more information on stirrup construction and placement.
- **Consolidate the grout with a concrete vibrator** to ensure the cores on the bottom course are filled.
- Remove any excess grout from the top of the panel block and any spillage on the block faces.
- Allow the concrete grout to harden a minimum of four hours.



### Step 5

- Stack additional post blocks in maximum of 6 courses or 4 ft (1.2 m) lifts. Always double check for alignment and plumb. Shim and adjust as necessary and brace as required.
- The 2 x 12 post spacer can be used by sliding it through the panel area.
- Next, fill the posts with grout or concrete mix in lifts not to exceed the 6 courses.
- Consolidate the grout or concrete with a concrete vibrator.
- If additional rebar is required, place it into the grouted cells in conjunction with the stacking of post blocks.

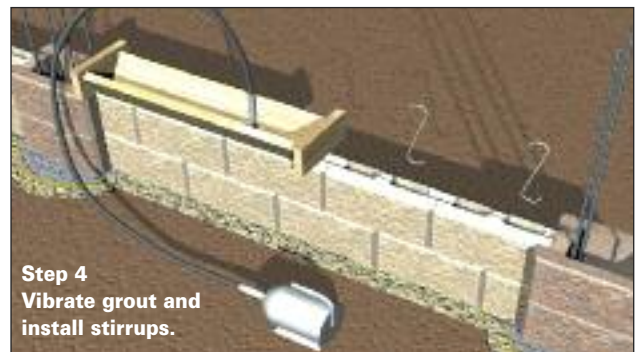

- Maintain a minimum lap splice of 24 in. (610 mm) when more than one length of rebar is required during construction of post. Check to see if there are local codes that require longer lap splices. Cold joints should be located in the middle of the block.
- Allow the concrete to harden a minimum of two hours.
- Post blocks must be installed within a  $\pm 1/2^\circ$  from vertical.

#### Rebar Lap Splice

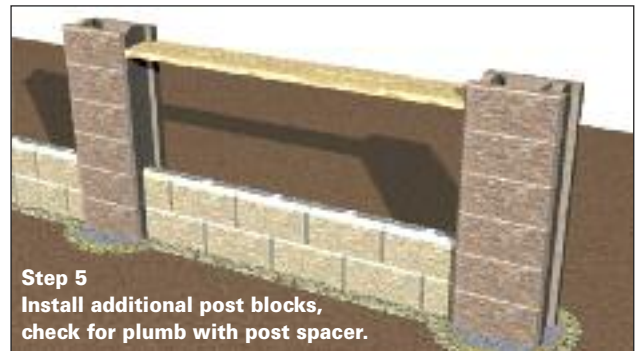
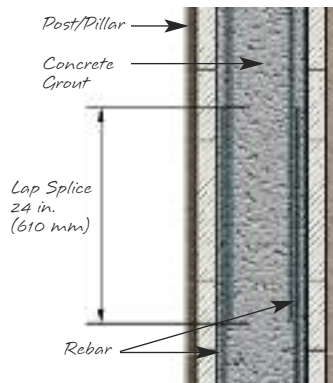

### If building a patterned fence project, skip ahead to page 35 for Step 6.

**Note:** The AB Fence uses two different types of concrete during construction. The piles and AB Fence Post Blocks use concrete with gravel and sand size aggregate. This type of concrete is generally available from concrete plants and used in most types of construction. However, the bond beams require what is referred to as a fine mix concrete grout. This mixture of concrete uses only sand as the aggregate, which makes it ideal for filling the smaller cores of the AB Fence Panel Block.

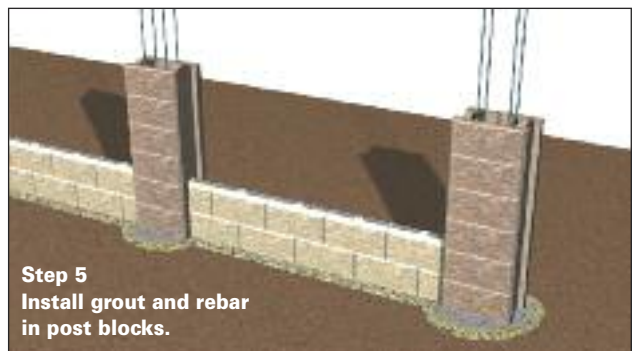

## Step 6

- Stack the panel blocks in between the post columns up to the next bond beam position. The panel blocks should be stacked in a running bond pattern, paying attention to level and plumb.
- Before stacking the next two bond beam courses, place a 4 in. (100 mm) strip of grout stop material, such as duct tape or building paper.
- Stack the first bond beam course directly on top of the grout stop in a running bond pattern.
- Place a continuous piece of #4 (10M) rebar on the recess on the top of the first bond beam course.
- Stack the second bond beam course in a running bond pattern.

- Seat and straighten the panel with a 4 ft level and a dead blow hammer by striking the front and back sides of the panel.

### Vertical Panel Tolerance

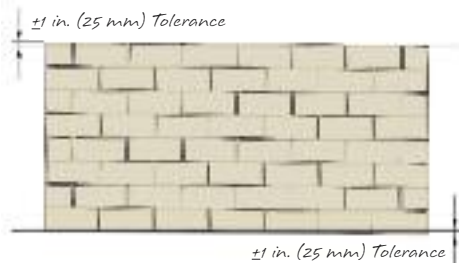

- Panels must be installed to a tolerance of ±1 in. (25 mm) in the vertical direction over the length of panel.

## Step 7

- Repeat Step 4 to grout the bond beam. Allow the concrete grout in this bond beam to harden a minimum of two hours. Repeat Steps 5 through 7 until design height is reached.

## Step 8

- Place AB Fence Cap Blocks on top of the post columns and the panels. The cap blocks on the panel sections should be installed in a running bond pattern.
- Cut AB Fence Cap Blocks to fit each end of the panel with a concrete saw using a diamond blade.
- All cap blocks must be attached with a flexible construction adhesive designed for exterior use on concrete surfaces, such as an NP1 sealant or similar.
- Place a bead of flexible construction adhesive the length of the block on both angled contact surfaces between the caps and post or panel blocks.
- Using a 4 ft. level and a dead blow hammer, set caps in place to obtain a level top-surface.

**Note:** When cutting blocks refer to MSDS sheets and wear proper safety gear.

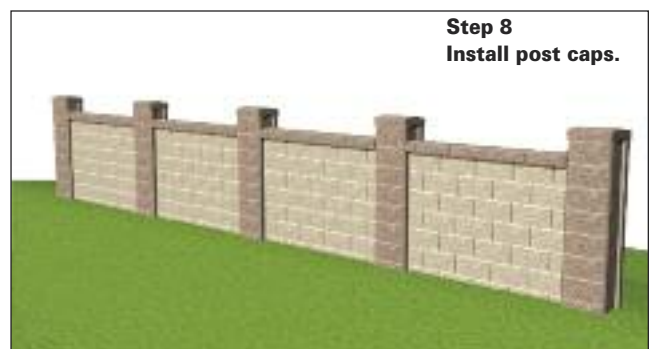
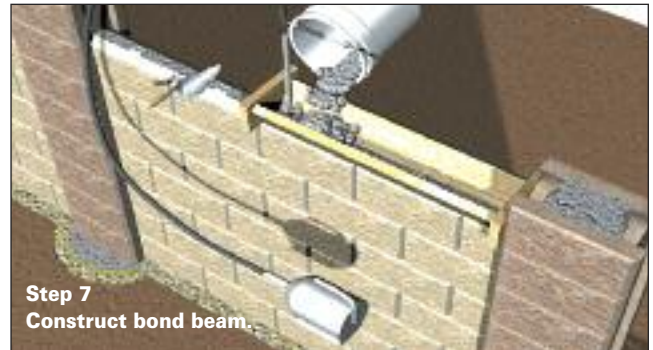

# Building AB Ashlar Blend™ Fence Panels



allanblock.com

Patterned fence panels resemble hand-laid stone walls and add even more character to the AB Fence System and require a higher level of detail and craftsmanship to construct than the standard panel. Plan on taking a little extra time to build a patterned fence, particularly when building one for the first time.

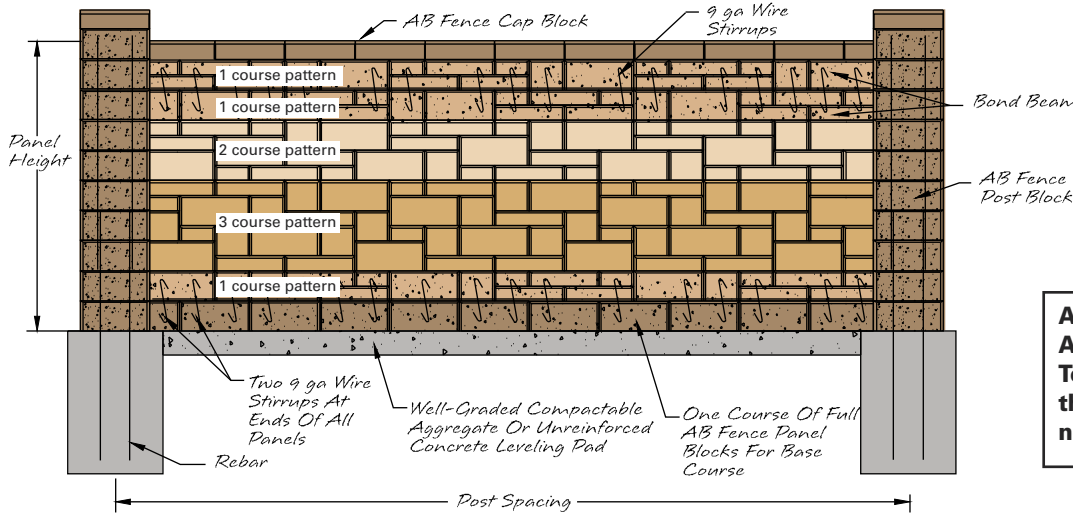

At allanblock.com the AB Fence Estimating Tool can easily calculate the blocks and materials needed for your project.

BUILD

## Wall Patterns

To assist in block estimating and to ease the construction process there are pre-set patterns available. A pre-set pattern is repeated for a particular pattern height and length. Remember, a single course consists of a full size block, approx. 8 in. tall (200 mm). Combine the different pre-set patterns to build any height fence required. These pre-set patterns can be flipped or reversed to keep the panels random.

### Standard Single Course Pattern



#### AB Fence Blocks needed:

- 2 Panel Blocks
- 2 Half Panel Blocks
- 6 Lite Panel Blocks
- 4 Half Lite Panel Blocks\*

### Standard Two Course Pattern



#### AB Fence Blocks needed:

- 6 Panel Blocks
- 4 Half Panel Blocks
- 8 Lite Panel Blocks
- 8 Half Lite Panel Blocks\*

### Standard Three Course Pattern



#### AB Fence Blocks needed:

- 10 Panel Blocks
- 10 Half Panel Blocks
- 10 Lite Panel Blocks
- 4 Half Lite Panel Blocks\*

### Standard Four Course Pattern



#### AB Fence Blocks needed:

- 15 Panel Blocks
- 12 Half Panel Blocks
- 10 Lite Panel Blocks
- 8 Half Lite Panel Blocks\*

\* Check with your local manufacturer on availability. In areas where the AB Half Lite Panel Block is not produced, use an AB Fence Lite Panel Block cut in half to create two AB Fence Half Lite Panel Blocks.

# Building Patterned Fence Panels

Refer to page 26 for a detailed description on how to start AB Fence construction. The initial steps include proper layout of the fence, jig construction, placement of the concrete forms, construction of the pile footings, location of the rebar within the pile footings, trench preparation and initial block coursing of posts and panels.

**Note:** The base course of the panel should always use a full course of the AB Fence Panel Block. This will speed the leveling and installation of the panel.

The following steps will compliment the installation procedure outlined on the previous pages. The changes to the typical installation for the construction of a patterned fence are as follows.

## Step 3: Post and Patterned Panel Construction

- Stack a second course of panel blocks following the pre-set single course pattern. Repeat the pattern if the panel is longer than 10 ft (3.0 m). If a manufactured AB Fence Half Panel Block is not available, an AB Fence Panel Block must be cut to obtain two half panel blocks using a concrete saw and diamond blade. By following the pre-set single course pattern the bond beam will still consist of two full courses.
- Check the first two courses of panel block for alignment and plumb. Shim and adjust as necessary.
- Additional vertical stirrups will be needed to meet the one per block minimum. Additionally, a vertical stirrup should be placed in each of the first two cores at each end of the bond beam.

**Continue with Steps 4-5 starting on page 31 to continue.**

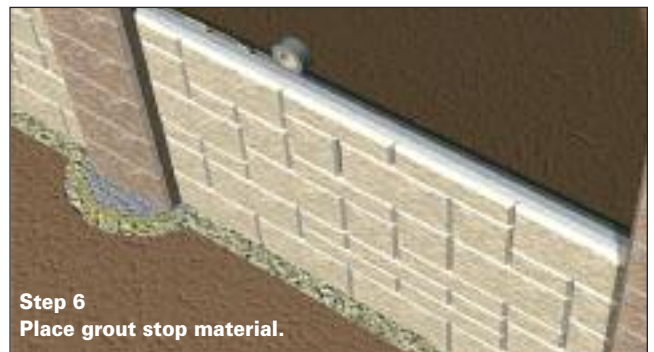
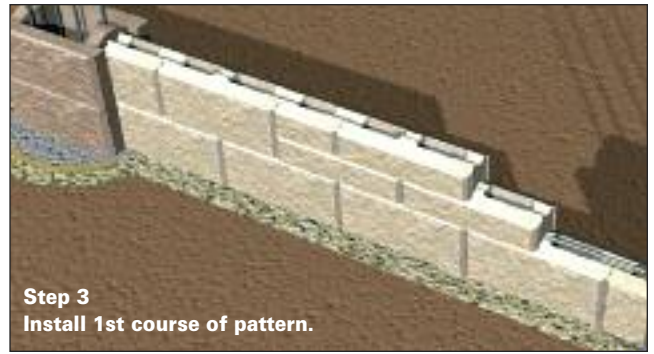



allanblock.com

## Step 6: Post and Patterned Panel Construction

- Using the pre-set patterns in any combination, stack the panel blocks in between the post columns up to the course below the top bond beam. For example, if there are seven courses between the bond beams, use a combination of the 4-course and 3-course pre-set patterns. The panel blocks should be stacked tight, paying attention to level and plumb.
- Before stacking the top two courses, place a 4 in. (100 mm) strip of grout stop material, such as duct tape or building paper.
- Using the pre-set single course pattern, stack the first course of the next bond beam directly on top of the grout stop material.
- Place a continuous piece of #4 (10M) rebar for the horizontal bond beam on the recess on top of the AB Fence Panel Block.
- Stack the second course of the next bond beam using the single course pre-set pattern. This patterned course should be offset or flipped from the pattern below to avoid a repetitive look.
- Seat and straighten the panel with a 4 ft level and a dead blow hammer by striking the front and back sides of the panel.
- Panels must be installed to a tolerance of  $\pm 1$  in. (25 mm) in the vertical direction over the length of panel. See the Vertical Panel Tolerance on page 32.

**Continue with Steps 7-8 on page 32 to continue.**



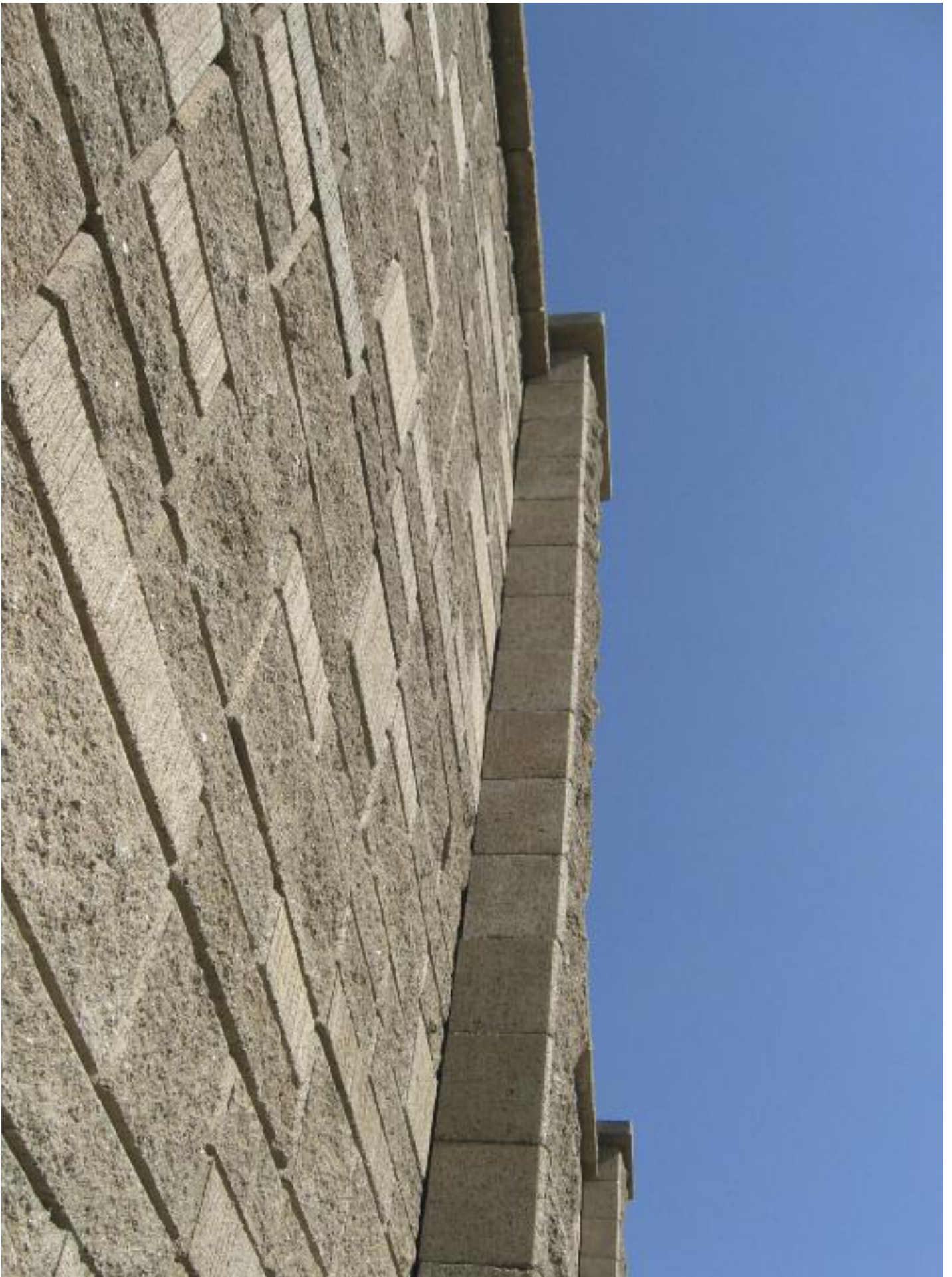

# CONSTRUCTION DETAILS



[allanblock.com](http://allanblock.com)

# Step-Ups & Step-Downs

The floating panels of the AB Fence do not require continuous footings, making steps and elevation transitions easy, while dramatically reducing construction costs. For slight grade changes it is easy to step the panels at the post locations, but more severe grade changes might require additional changes within the panel itself. Always keep a portion of the fence buried when establishing and making the grade transitions. For more information on changes within the panel see Panel Step Down Detail on page 44.



## Stepping Down the Panel

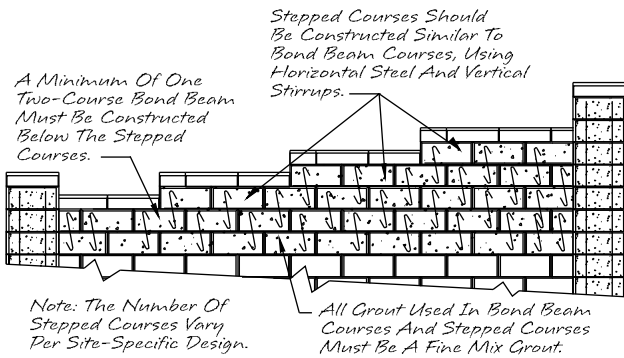

## Stepping Up the Panel

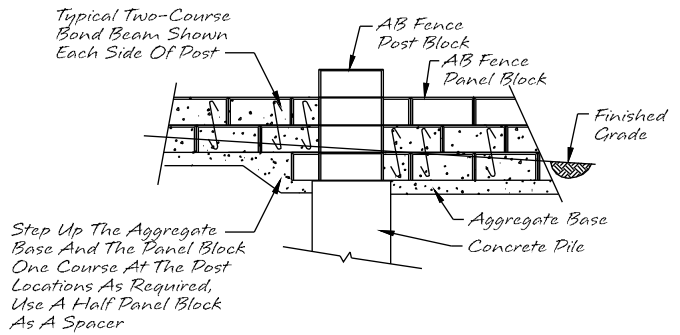

# Gates & Accent Railings

The concrete filled post blocks provide a secure backing for nearly any gate type and configuration for residential or commercial applications. Heavy gates may require wheels of their own to keep the posts from deflecting under the gate's weight. Always confirm with the project engineer for the best way to support the gate structure.

Railings can also be added to the top of the AB Fence to offer a softer looking fence with great curb appeal. This is a good option where screening is needed.

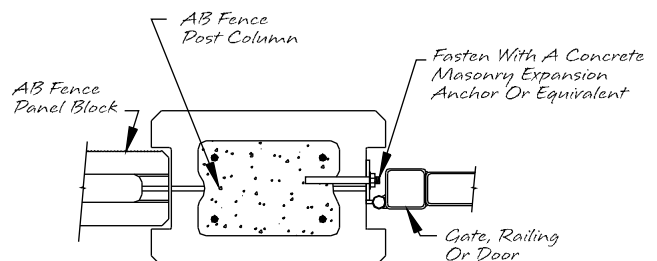



## Curves

The post and panel connection offers the flexibility to create fluid curves and radiuses unmatched by other fencing systems. The length of the panel and the type of connection, Standard or Modified, will determine the radius of the fence, see the Minimum Radius Chart and connection details below.



allanblock.com

Other dramatic transitions can be achieved by mitering the post block to the desired angle. See construction detail on page 40.

### AB Fence Minimum Radius Chart

Post/Panel Connection	Panel Width in full AB Panel Block length						
	4 blocks	5 blocks	6 blocks	7 blocks	8 blocks	9 blocks	10 blocks
Standard	65 ft.	79 ft.	92 ft.	106 ft.	119 ft.	133 ft.	146 ft.
	20 m	24 m	28 m	32 m	36 m	40 m	44 m
Modified	20 ft.	24 ft.	28 ft.	33 ft.	37 ft.	41 ft.	45 ft.
	6 m	7 m	9 m	10 m	11 m	12 m	13 m

**Note:** Each AB Fence Panel Block is approximately 1.5 ft (0.46 m) long. To get an approximate center-to-center post spacing multiply the number of panel blocks by 1.5 ft (0.46 m) and add 1 ft (0.3) to account for post blocks. This is used to obtain an estimated length and not for fence construction.

## Entryways

Create entryway displays in any shape and size for residential or commercial developments.



## Lighting

Lighting brings new possibilities to any landscape. Add a dramatic look with ground mounted or with decorative fixtures secured to the top or sides of the AB Fence posts.

Always follow local electrical codes and lighting manufacturers guidelines.



### Standard Connection

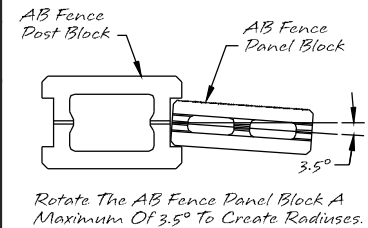

### Modified Connection

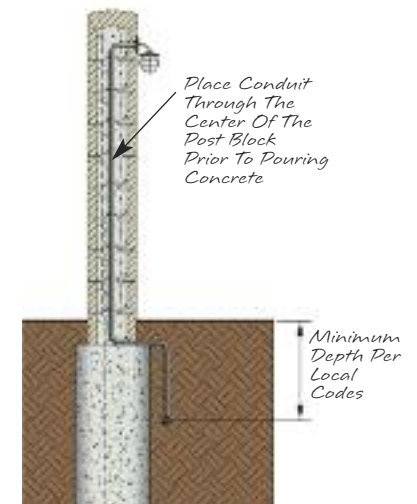
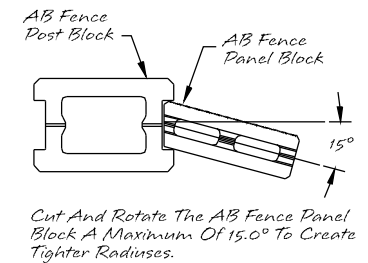

# Corners and Miter Cutting Blocks

The AB Fence Corner Block makes the construction of a 90 degree corner easy. No special tools or cutting of blocks are required. When laying out the fence to include the corner and adjacent post locations, keep in mind the post spacing is slightly shorter than a panel without a corner post. This will eliminate cutting panel blocks later in the installation process.

For more details and information on constructing a corner cap, see the AB Fence Tech Sheet #2005 at [allanblock.com](http://allanblock.com).



## Corner Block with Rebar Placement

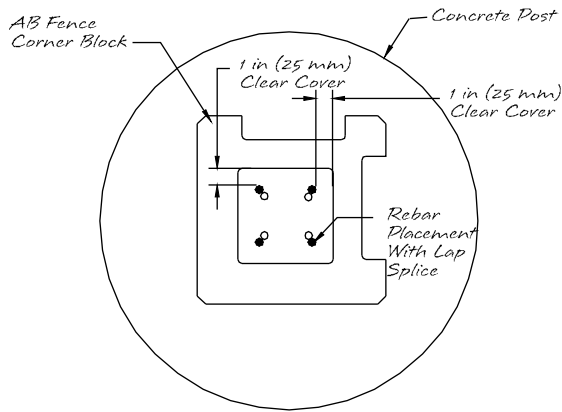

## Building with the AB Corner Block

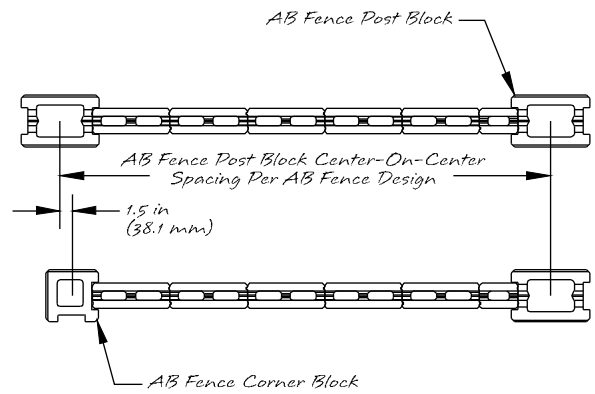

For each corner location the center-on-center spacing needs to be reduced by 1.5 in. (38 mm). If AB Fence Corner Blocks are used on both ends of a panel, the center-on-center spacing is 3 in. (75 mm) shorter than if two AB Fence Post Blocks are used. See the AB Fence Tech Sheet #2005 at [allanblock.com](http://allanblock.com) for additional information.

If AB Fence Corner Blocks are not available, or a custom angle is needed, two AB Fence Post Blocks can be miter cut to fit the desired angle.

## Cutting Post Blocks to Make a Corner

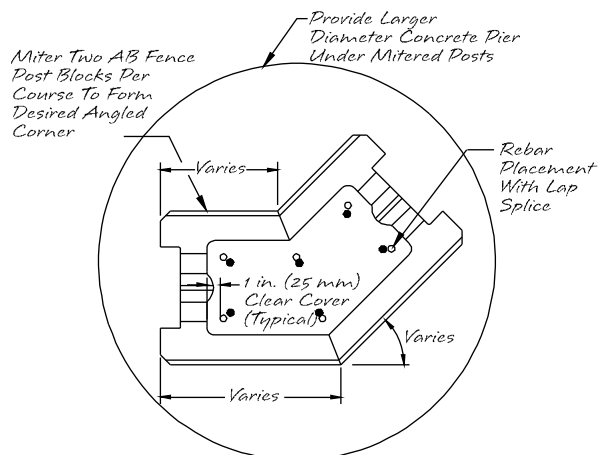

# Top of AB Fence Options



allanblock.com

The AB Fence can be completed using the AB Fence Cap Blocks that gives any project a clean, finished look with aesthetic appeal. By adjusting the height of the AB Post Block, you can create two different types of looks.

- Castellated Finish
- Non-Castellated Finish

The **preferred method is a castellated finish** where the posts are taller than the panel by at least one block. The castellated finish allows room for the wall panels to slide up and down as needed due to frost heave. It is also easier to construct since you are not matching the post and panel heights.

Using different colors within the panel or the caps is also a great way to give the AB Fence a dramatic look. Reversing the direction on a course of block easily adds a banding effect with the change in texture.

**Castellated Finish**

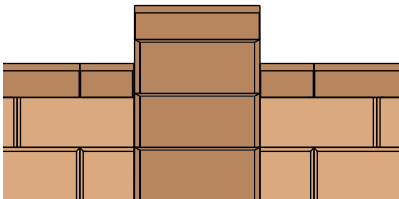

**Non-Castellated Finish**

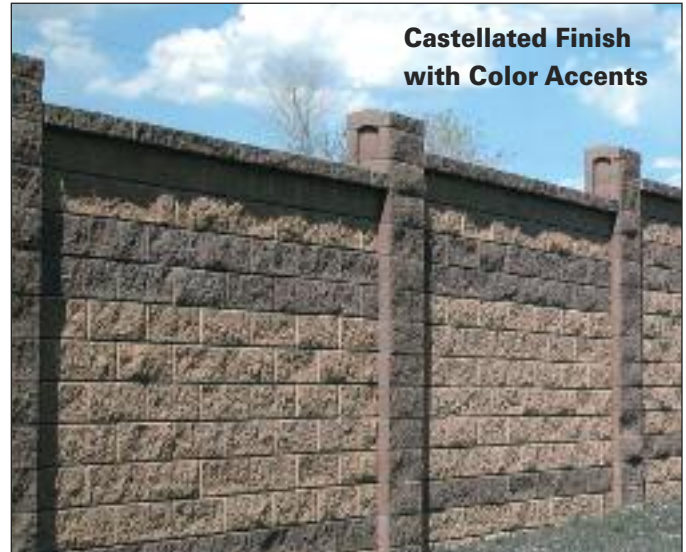
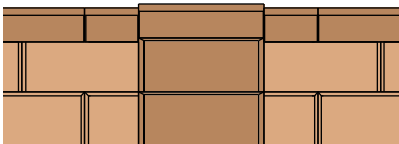

**Castellated Finish with Color Accents**



**Castellated Finish with Texture Banding**



**Non-Castellated Finish with Step-ups**



**Castellated Finish**



**Non-Castellated Finish**

# Water Management

The design and performance of most fence structures are based on keeping the area around the fence relatively dry. To ensure a quality project, the soils must not become saturated during construction and the final design must route water in a manner to prevent water from building up around the structure. Incorporating berms and swales into the final design is an easy way to direct surface water away from the fence.

During the design process, develop a thorough understanding of the site and determine where the water will come from and how it will be properly managed. If the water cannot be diverted around or away from the fence, it may require installing an opening in the panel to allow the water to move under the fence. You may need to consult with an engineer to ensure that the water has been accounted for in your design.

During the building process, stage your materials so surface runoff is not directed improperly. Temporary grading may be needed to ensure water will not drain toward the construction area. It is also good practice to cover the fence area at the end of the day to prevent water saturation if rain is in the forecast.



## Water Drainage Option

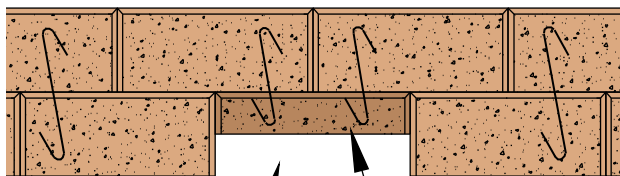

Opening For Water Drainage. (Actual Location In The Bond Beam To Be Determined By Site Layout - One Per Panel Maximum)

AB Fence Lite Panel Block

- During the first course placement and at the location in the panel where water needs to be directed under the fence, replace one full panel block with an AB Fence Lite Panel Block and a wood or foam block spacer that is approximately 4 in. (100 mm) high. The block and spacer together should equal the height of one AB Fence Panel Block.
- Continue with standard bond beam construction, placing rebar and second course of block.
- Install shorter stirrups when grouting the bond beam in both cores of the AB Fence Lite Panel Block.
- Remove wood or foam spacer only when bond beam has fully cured.

# Compaction

When building your AB Fence it is important to remember to compact the soil under the fence. Proper compaction is important to a beautiful finished project. If performed improperly, settlement could occur and result in structural failure or unnecessary maintenance cost.

## Why is compaction important?

The main reason to compact soil is to prevent soil from settling and damaging the structure. Compacted soil provides stability and increases the load-bearing capacity while reducing water seepage into the soil which minimizes future water issues.

## Compaction and the AB Fence

It is important to remember that ANY loose material in and around the fence should be compacted. However, there are two specific installation steps in which proper compaction is noted.

1. When the pile holes are excavated each hole must be checked to make sure loose material is not left in the bottom of the hole. Use a long handled hand tamper to compact this soil when necessary.
2. The trench below the panels needs to be compacted prior to placing the well-graded granular aggregate. This will ensure that the panel is constructed on solid ground. Any soft soil should be removed and replaced with aggregate when needed.

## Tools & Equipment you may need

**Hand Tools** Safety glasses, gloves, dust mask, ear protection, knee pads, 4' level, torpedo level, tape measure, string line, chisel, hand tamper, dead blow hammer, shims, round and square shovel.

**Power Tools** Plate compactor, concrete saw with diamond blade, concrete mixer, concrete vibrator, skid loader with auger and laser level.

## Rental Equipment

Plate compactors, concrete saws, concrete mixers, concrete vibrator, skid loaders and laser levels are required when building an AB Fence project. These are available at most equipment rental centers.



allanblock.com



### Safety First

As with all construction equipment, there are many safety practices that should be followed while using compaction equipment. Keep in mind the personal protection basics that consist of durable work gloves, eye protection, ear protection, dust mask and appropriate work clothes. Make sure you are familiar with the equipment. If possible, ask for some training when picking the equipment up.

**We recommend reading all operating and safety instructions before operating the machinery.**



# AB Fence Sections

The following drawings provide details for basic construction and design options available with the Allan Block Fence System. These drawings are to be used as reference only and not for construction. Use the approved construction design information for project details.

## Typical AB Fence Section

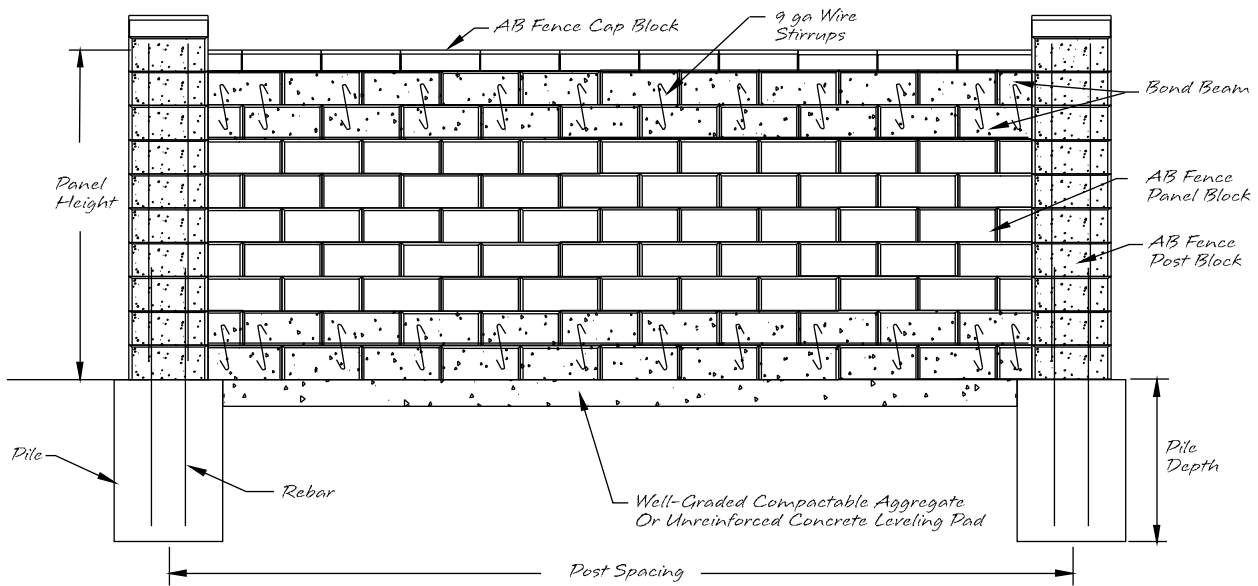

## Panel Step Down

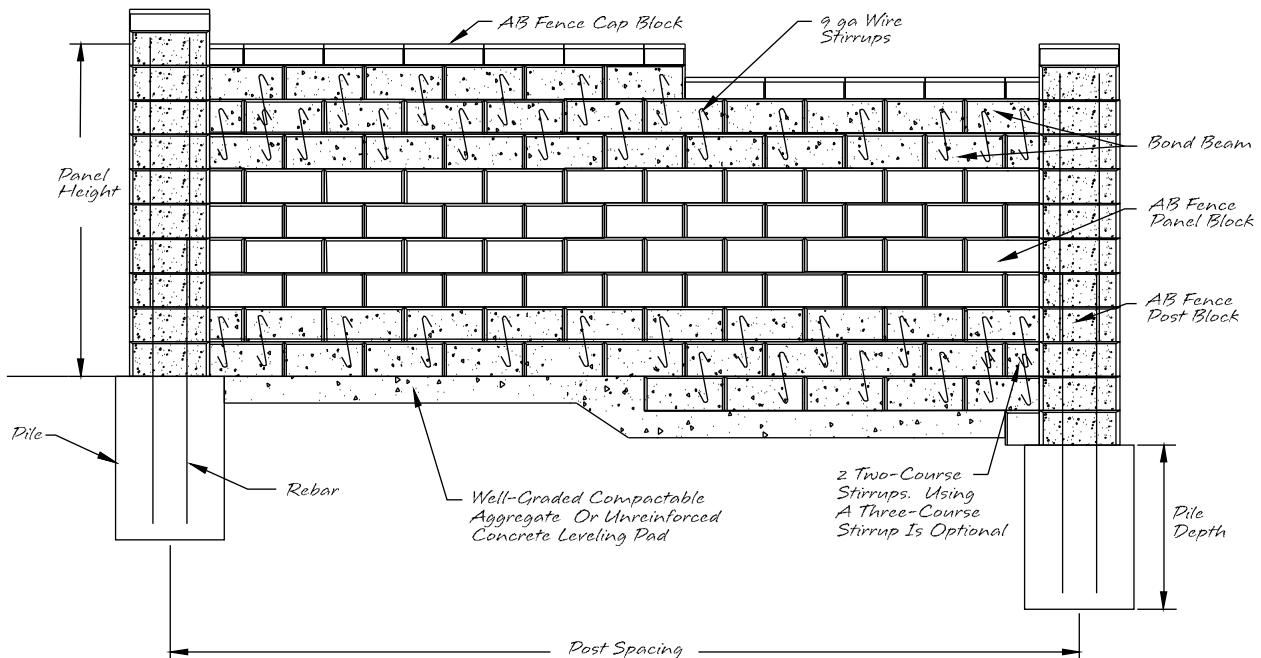

# Bond Beam Considerations



allanblock.com

When building a patterned fence, the bond beam can be constructed either with full height blocks as shown in the Standard Bond Beam Construction detail, or by using the single course pre-set pattern as depicted in the Patterned Bond Beam Construction detail shown below. Proper consolidation of the concrete grout as well as placement of the horizontal steel and wire stirrups are required for both options. Wire stirrups are needed in **each of the first two cores from each end and in every other core or one per block (min)**. A concrete vibrator is required when placing concrete.

## AB Ashlar Blend Pattern Fence - Standard Bond Beam Construction

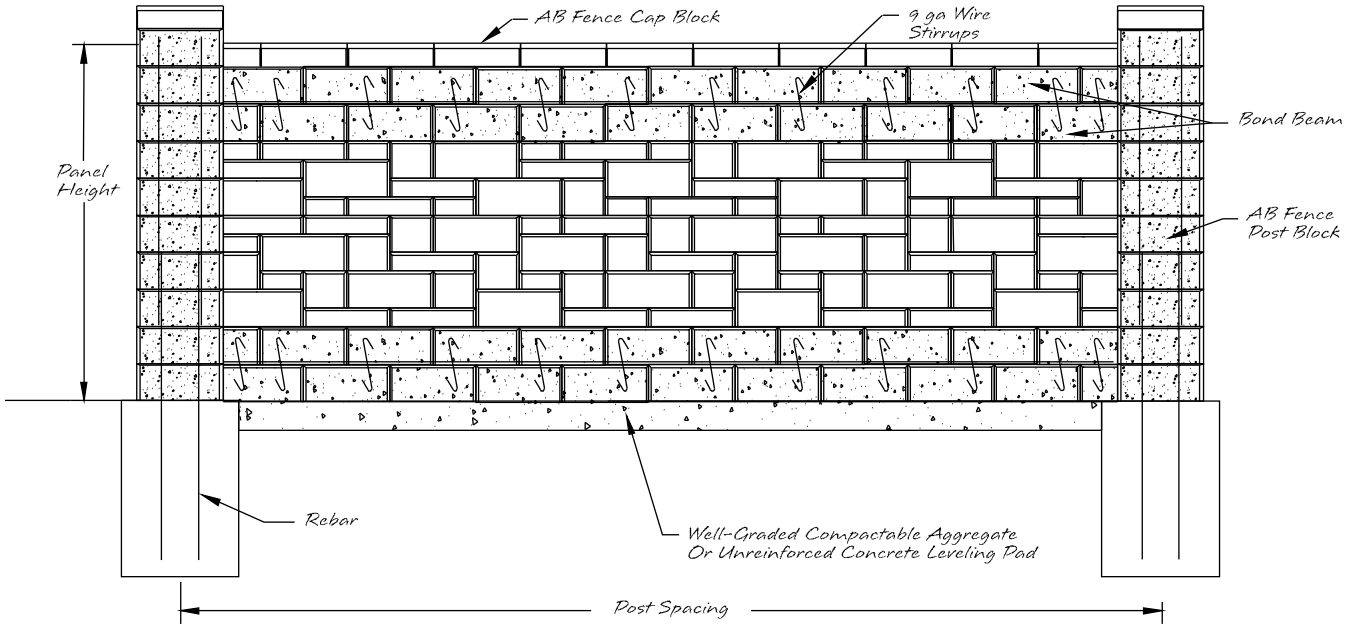

## AB Ashlar Blend Pattern Fence - Patterned Bond Beam Construction

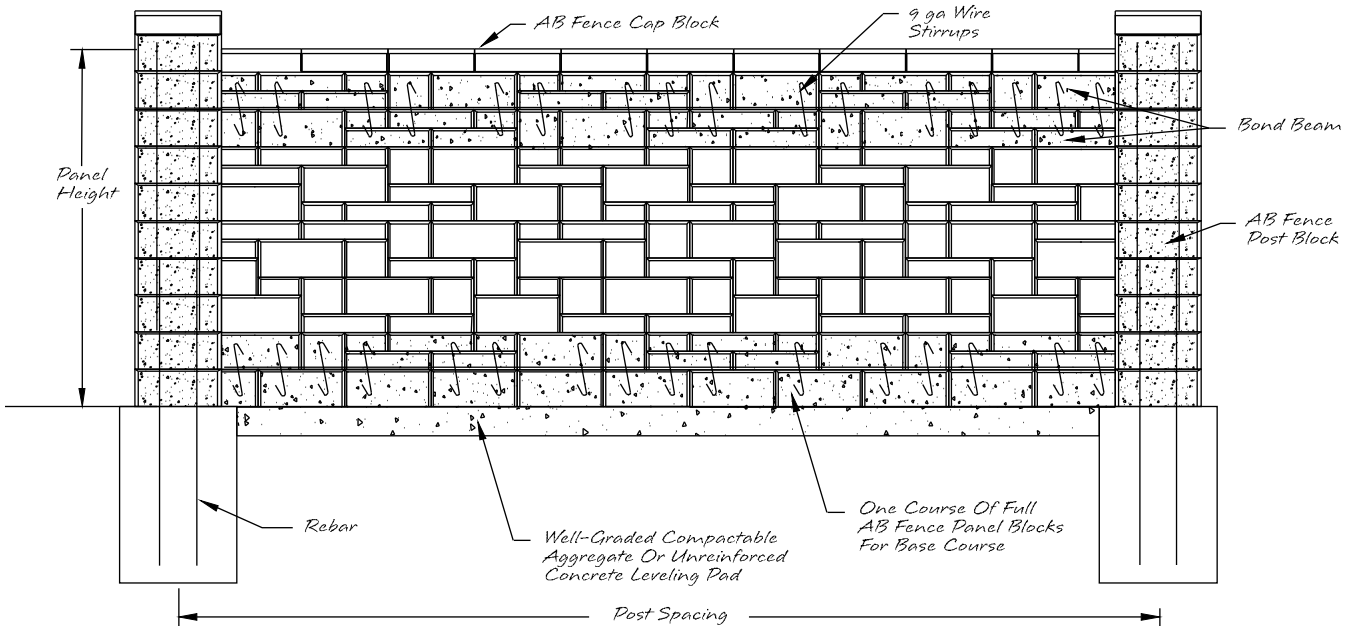

# Building a Bond Beam

A single bond beam consists of two courses of AB Fence Panel Block that have their cores filled with sand mix grout. Horizontal steel is placed between the two courses of block and will reinforce the entire bond beam. For additional support, wire stirrups are placed in each of the first two cores from each end and approximately every other core with one stirrup per block minimum, to ensure that the courses do not separate (ashlar patterned bond beams will require more vertical stirrups). This bond beam configuration creates a solid structural beam capable of reinforcing the panel structure. Bond beams are used at the top and bottom of the panel to create a unified panel structure. Intermediate bond beams are required as the AB Fence height increases.

- Place first bond beam course, lay in rebar on the top of the blocks. Rebar is commonly available at local suppliers in 10 ft. and 20 ft. sections (3 m and 6 m).
- Place second bond beam course.
- Using funnel, start filling the blocks with grout.
- Place stirrups in blocks.
- Consolidate grout with a concrete vibrator.
- Place additional grout to top off blocks after vibrating.
- Entire bond beam must be cast at the same time.
- Allow finished bond beam to cure four hours before stacking additional courses.

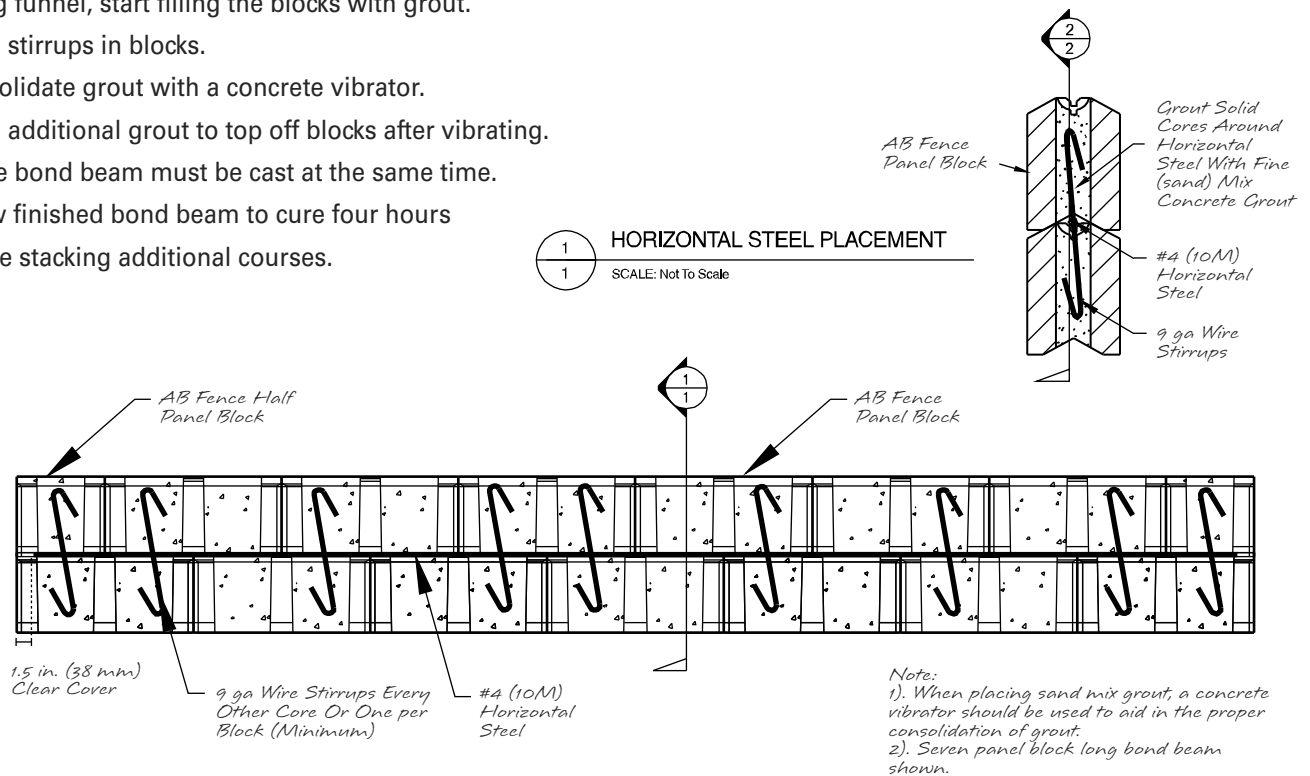

## Ashlar Pattern Bottom Bond Beam Placement

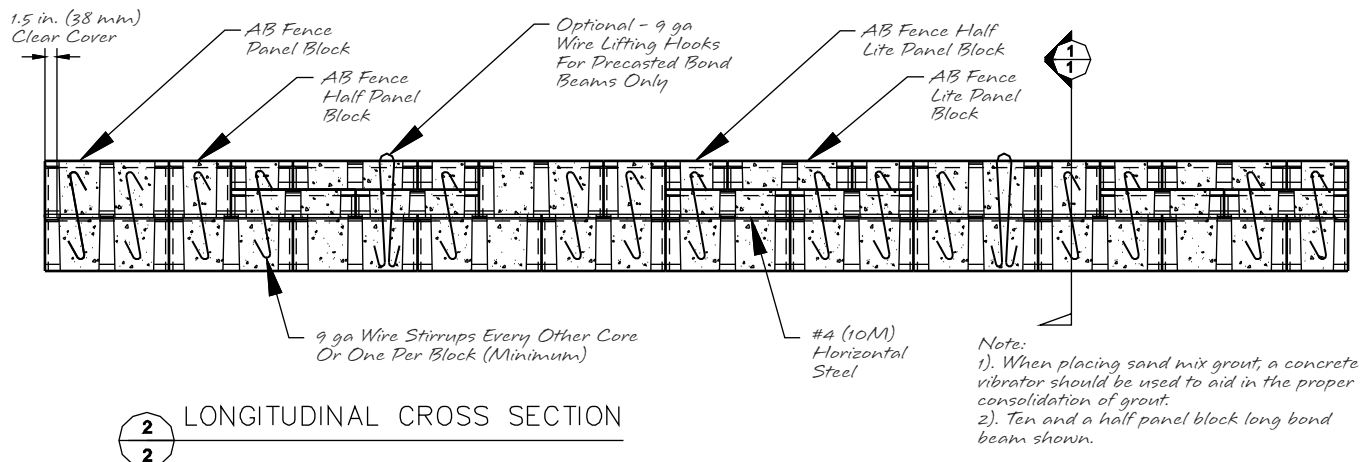



allanblock.com

**Note:** The AB Fence uses two different types of concrete during construction. The piles and AB Fence Post Blocks use concrete with gravel and sand size aggregate. This type of concrete is generally available from concrete plants and used in most types of construction. However, the bond beams require what is referred to as a **fine mix** concrete grout. This mixture of concrete uses only sand as the aggregate, which makes it ideal for filling the smaller cores of the AB Fence Panel Block.

### Stirrup Jig For 2 Course Bond Beam

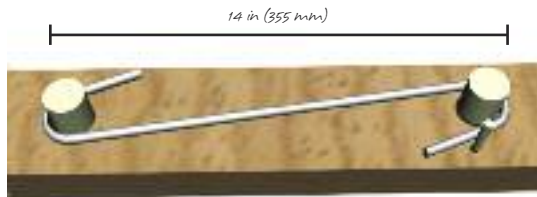

Install stirrups as described on page 46 prior to vibrating. This will ensure a quality bond beam for maximum stability.

For more information on constructing a jig for the stirrups see page 25.



**Pre-Made Bond Beams**

### Drainage Detail

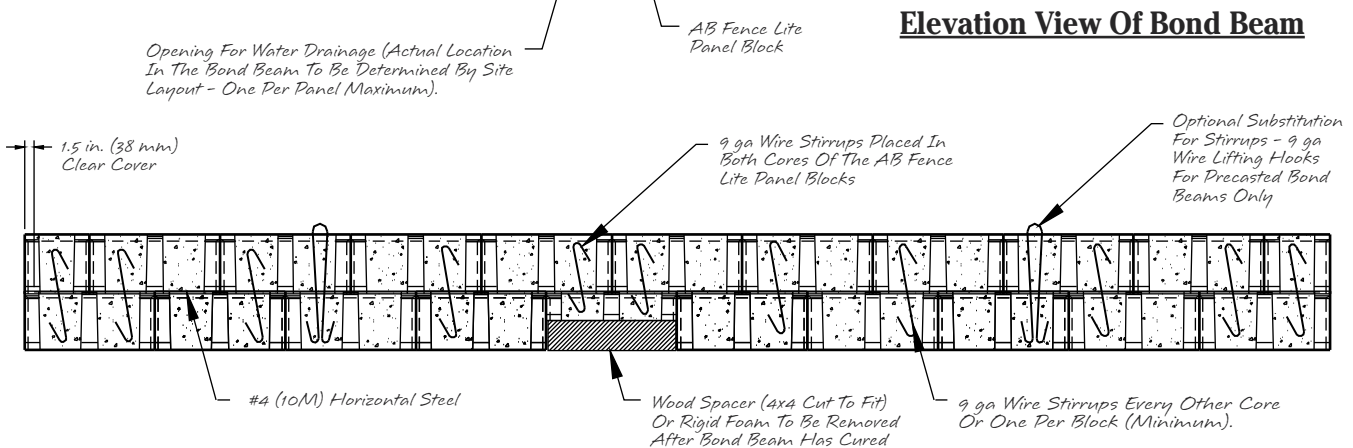
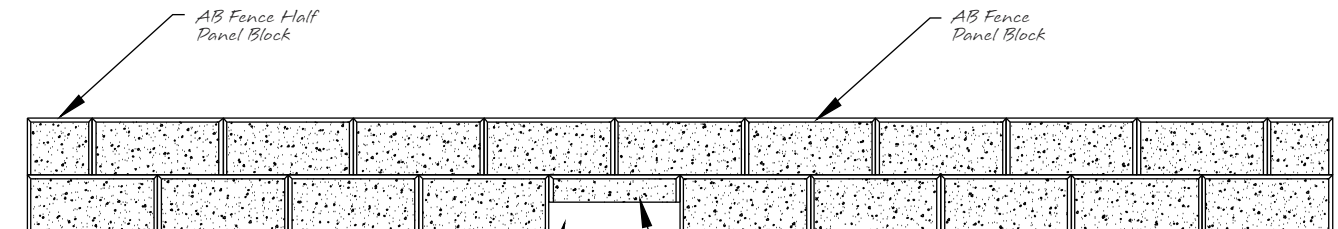

**Note:**  
 1). When placing sand mix grout, a concrete vibrator should be used to aid in the proper consolidation of grout.  
 2). Ten panel block long bond beam shown.

### Longitudinal Cross Section



# SPECIFICATIONS AND TESTING



[allanblock.com](http://allanblock.com)

# Specifications and Testing

## SECTION 1

### PART 1: GENERAL

#### 1.1 Scope

Work includes furnishing and installing modular concrete block fencing system to the heights and lengths specified on the construction drawings and as specified herein.

#### 1.2 Reference Standards

ASTM C1372 Standard Specifications for Segmental Retaining Wall Units.

#### 1.3 Delivery Storage, and Handling

- A. Contractor shall check the materials upon delivery to assure proper material has been received.
- B. Contractor shall prevent excessive mud, concrete, and like construction materials from coming in contact with the materials.
- C. Contractor shall protect the materials from damage once on site. Damaged materials including cracked and chipped block beyond allowances provided for in ASTM C1372 must not be used in the fence.

### PART 2: MATERIALS

#### 2.1 AB Fence Systems Units

- A. System units shall be AB Fence System units as produced by a licensed manufacturer.
- B. System units shall have a minimum 28 day compressive strength of 3000 psi (20.7 MPa) in accordance with ASTM C1372. The concrete units shall have adequate freeze-thaw protection with an average absorption rate of 7.5 lb/ft<sup>3</sup> (120 kg/m<sup>3</sup>) for northern climates and 10 lb/ft<sup>3</sup> (160 kg/m<sup>3</sup>) for southern climates.
- C. Exterior dimensions shall be uniform and consistent. Maximum dimensional deviations shall be 1/8 in. (3 mm), not including textured face.
- D. Exterior shall be textured or striated or a combination of both. Color as specified by the project owner.

#### 2.2 Pile and Post Concrete

- A. Concrete used to construct the piles and fill the post block must have a minimum compressive strength of 3000 psi (20.7 MPa).

#### 2.3 Concrete Grout

- A. Concrete grout used as unit core fill for bond beam panel blocks shall conform to ASTM C476 and have a minimum compressive strength of 3000 psi (20.7 MPa) with Fine Aggregate Grading Requirements defined by ASTM C404.

#### 2.4 Steel Reinforcement

- A. All reinforcing bars shall be deformed billet steel conforming to ASTM A615 grade 60. Bars shall be branded by the manufacturer with bar size and grade of steel, and certified mill reports shall be submitted for record.

#### 2.5 Construction Adhesive

- A. Exterior grade construction adhesive used to adhere the cap block to both the posts and panels shall be NP1 as manufactured by BASF (or equivalent).

#### 2.6 Shimming Material

- A. Material used for permanent shimming must be non-degradable.

### PART 3: SYSTEM CONSTRUCTION

#### 3.1 Layout

- A. Excavate a 6 in. (150 mm) deep by 12 in. (300 mm) wide trench along the centerline of the AB Fence the entire length of the fence.
- B. To ensure accurate post spacing, installer shall follow all guidelines set forth in the Installation Manual for the AB Fence System.
- C. The center of each pile hole must be located and drilled to a maximum horizontal tolerance of  $\pm 1$  in. (25 mm). The depth and diameter must be at least that specified in design.
- D. The top of the pile holes shall be set to a maximum of 1 in. (25 mm) below the design elevation of the pile. A 12 in. (300 mm) tall piece of cylindrical tubing material having a diameter of 24 in. (600 mm) is recommended to form up the top of the hole for setting the pile cap elevation.

#### 3.2 Pile Construction

- A. Pour concrete into the pile hole meeting the strength requirements for the pile concrete and finish to a 1 in. (25 mm) maximum elevation difference.
- B. Place vertical steel reinforcement into the wet pile concrete within 0.5 in. (13 mm) of the design horizontal location for the steel. The steel bars must extend into the pile to the depth specified in the design with a minimum clear cover at the bottom of the pile of 3 in. (75 mm). The steel bars must also extend out the top of the pile a minimum distance to achieve a lap splice equal to the design requirements.
- C. Allow the concrete to harden 4 hrs at or above 40° F (4.4° C) or until hard enough to resist more than a surface scratch when scraped with steel rebar before placing post block.



allanblock.com

### 3.3 Post and Panel Construction

- A. Fill trench between each post to the design elevation of the bottom of the fence with a well graded compactible aggregate to 95% Standard Proctor.
- B. If necessary, set the first post block on a mortar bed at a maximum thickness of 1 in. (25 mm) to accommodate for elevation differences. Post block must be placed level and plumb in all directions. Allow adequate curing time for the mortar before placing additional post block courses. Mortar strength must meet or exceed that of the design requirements of the post and pile.
- C. The panels must extend a minimum of 1 in. (25 mm) into the post block columns.
- D. Horizontal steel reinforcement must be installed in the specified bond beam locations. The horizontal steel must have a 1.5 in. (38 mm) clear cover at each end.
- E. The blocks should be installed level in all directions and in a straight line from post to post. Total deviation of 0.125 in. (3 mm) is allowable.
- F. The panel block must be stacked in a running bond or preset blended pattern.
- G. One panel block course above and below the horizontal steel in the bond beam locations must be filled with fine mix concrete grout meeting the strength requirements, and consolidation with a concrete vibrator. All panel block associated with a bond beam must cast in a single pour.
- H. Place 9 ga wire (min.) stirrups in each of the first two cores from each end and approximately every other core with one stirrup per block minimum.
- I. Minimum curing time for concrete grout is 4 hrs for the bottom bond beam and 2 hrs for all other locations.
- J. Maximum stacking lifts and filling for the post blocks is 4 ft (1.2 m) or 6 courses. Vertical steel reinforcement shall maintain a 1 in. (25 mm) clear cover from all inside surfaces of the post block. Minimum lap splice requirements are 24 in. (610 mm) or per design requirements and local building codes.
- K. Completed post must be installed level and plumb in all directions and within a  $\pm 1/2^\circ$  tolerance.
- L. Panels must be installed to a tolerance of 1 in. (25 mm) in the horizontal direction over the length of panel and a tolerance of 0.375 in. (8 mm) in the vertical direction.

### Typical AB Fence Sections

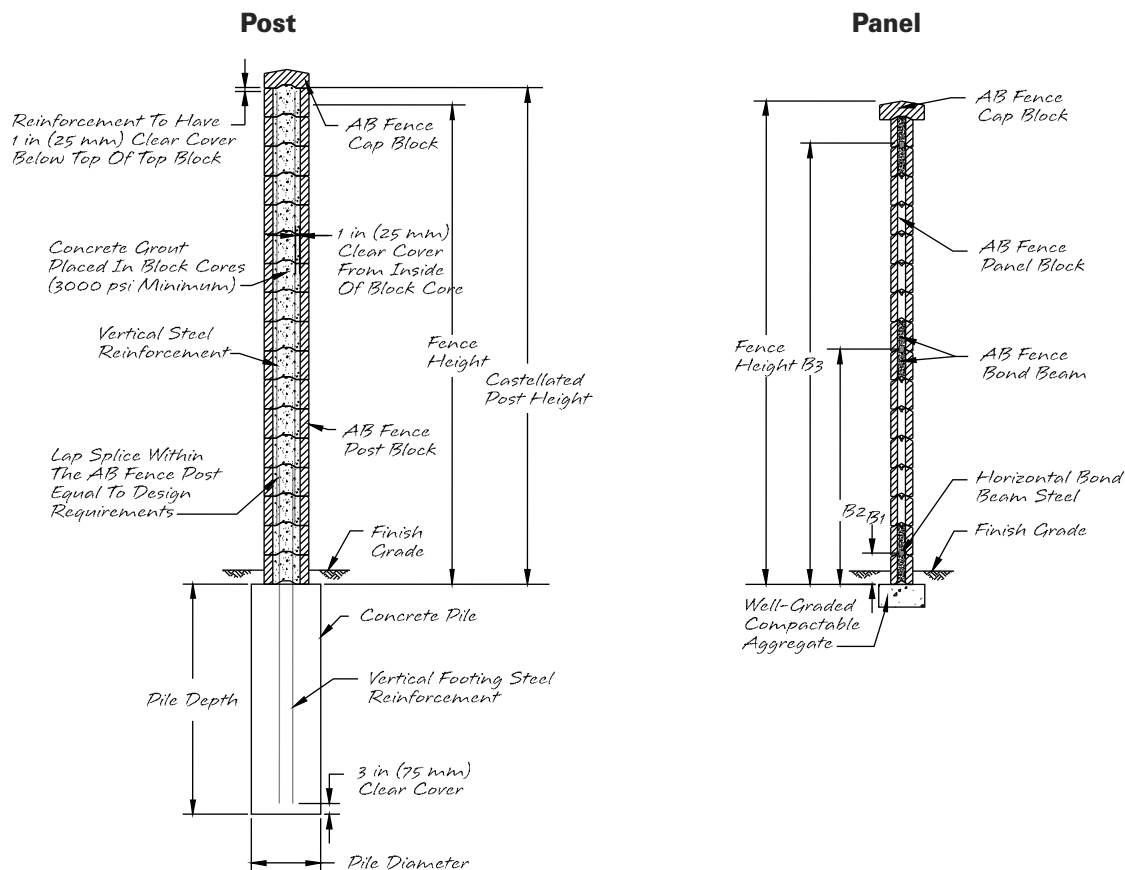

Consult the Allan Block Engineering Department for details 800-899-5309.

Specifications are subject to change without notice. This document was last updated 2/7/2011.

Visit [allanblock.com](http://allanblock.com) for more information

# Research and Testing of the AB Fence® System

Use of mortarless concrete blocks for retaining walls has been an acceptable construction practice since the late 1980s; however, this acceptance is credited to research and testing. Now that mortarless construction is used in the AB Fence System, additional research has been required to verify the system's capabilities. The AB Fence design methodology is a combination of timeless engineering principles and the following research topics:

- Self-weight resistance
- Bond beam capacity
- Full-scale panel testing
- Intermediate column testing

## Self-Weight Resistance

The AB Fence System has many advantages since it is a concrete system. It provides superior durability and low maintenance, but also provides weight similar to a gravity retaining wall. The weight of the system when combined with its eccentricity creates a moment that needs to be overcome before any applied force can actually engage the flexural steel.

Resisting moments are calculated based on the weight of the system and have been verified through research and testing. The designing engineer can utilize the self-weight resistance to reduce the applied moments at the base of the post.

## Bond Beam Capacity

The AB Fence uses the bond beams and dry-stacked units to transfer the wind load to the posts. The capacities of these bond beams are critical in the design calculations; therefore, bond beams were tested to compare the actual capacities to the ultimate moments based on the concrete and steel properties. Bond beams were laterally loaded and as the loads were applied the deflections were recorded. Then by using beam bending formulas the actual induced moments were calculated. These moments compared to the ultimate moments verified that the bond beam was acting as a composite structure and not as individual stacked parts.



*Top bond beam deflection.*

## Full-Scale Panel and Post Testing

Panel testing was conducted to examine how the bond beams and the dry-stacked units work together to resist the applied wind pressure and distribute these forces to the posts. The AB Fence Panel Block has a unique ball and socket configuration that creates a semi-rigid panel structure when interlocked together. In the panel test, a force was applied using an articulating frame to provide a uniform pressure on one side of the panel. The other side was outfitted with load cells to record how much pressure was being transferred to the posts. Post testing was conducted to confirm the capacity of the composite post. In the post test, a variable load was applied to determine a moment capacity and deflections were recorded to measure the plasticity of the post. The results of the tests focused on the following:

- The bond beams and the dry-stacked units work together to provide both flexural strength and flexibility.
- The dissipation of force within the dry-stacked units since all the force was not transferred to the posts.
- The additional strength the ball and socket interlock provides to the system.
- The composite post structure flexed and rebounded with repeatability and functioned as a monolithic concrete column.



*Hydraulic ram and frame assembly for AB Fence Post flexural test.*



allanblock.com

## Intermediate Column Testing

An aesthetic issue of large deflections in the center of the panel was noticed during the Full-Scale Panel Testing of the longer panel lengths. As the loads increased on the panel, the center of the panel started to bulge out. This bulge would not completely rebound even though the bond beams would rebound to their initial conditions once the loads were removed. A center intermediate column solved the panel bulging. The intermediate column is simple to construct since it consists of adding a single vertical rebar running through the cores of the dry stacked panel block. These vertical cores are then filled with fine mixed concrete grout. It is not required to have the intermediate column extend into the bond beams located above or below. During testing, when the intermediate column was added the bulge was eliminated after the loads were removed and the panel rebounded. It was also recorded that the load transfer to the posts was not affected by adding the intermediate column. Since the large deflections were only noticed on the longer panel spacing under very high loading, it is Allan Blocks recommendation that the intermediate columns are only used on panels over 15 feet long (4.6 m), which will be subject to extreme wind loads. Under normal wind loading the intermediate column is not necessary.

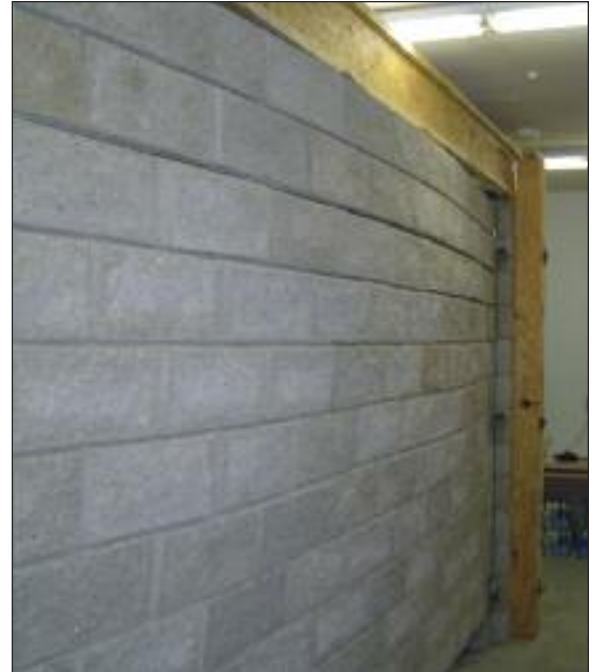

*Flexing panel with Intermediate Column*

## Panel Frost Heave or Ground Swelling Testing

One advantage of the AB Fence System is the ability of the fence panel to handle movement and loads exerted from the underside. To test the system's capabilities, different structures were constructed to model a variety of field applications. The panel structures were constructed and then allowed to free span between the two pile caps once the bond beams had cured. Hydraulic jacks and steel plates were placed under the fence panel at three different locations, the two ends and at the center point. Individually, each jack was then used to exert loads from the underside and the wall deflections were measured using dial gauges at six different locations. The Frost Heave Testing illustrated that the two-course bond beam with the vertical stirrups and single horizontal steel could handle extreme loads in localized areas under the panel assembly.



*Assembled block wall with hydraulic jacks under the panel span for uplift test.*



# ESTIMATING / DESIGN TABLES



[allanblock.com](http://allanblock.com)

# AB Fence Construction and Inspection Checklist

We have prepared the following Construction and Inspection Checklist to provide a list of items covering the basics for your fence project. It may also be used during the bidding process and at preconstruction meetings to ensure that all special provisions are complied with. Always check with local building codes, document any changes to the plan in writing and notify the fence design engineer with any concerns.

## Review Fence Design Plans For:

### A. Compliance of Site to Latest Site Plan

- Yes  No - Does the site plan and fence layout in both height and length coincide with the current Site Plan?
- Yes  No - Are the changes in direction within the capabilities of the fence system (3°, 15°, 45°, 90°)?
- Yes  No - Does the fence design contain a castellated system (post block one course higher than panel) as recommended? If not, is it possible to change to this format?
- Yes  No - How are slopes and grade changes accounted for during the fence layout?
- Yes  No - If the fence systems utilizes pile caps and if there is a downward slope on either side of the fence, is the slope taken into consideration so as to not expose the pile cap?
- Yes  No - Have site utilities been accounted for? Have all respective local utility companies been contacted (Use your local "Call Before You Dig" hotline)?
- Yes  No - Does the dimensional layout of the fence take into consideration panel block width vs. utility locations so they correspond and do not conflict?
- Yes  No - Are there any recommendations for changes to the site plans to accommodate the fence?

### B. Review of Reported Soil Conditions with On-Site Soils Engineer

- Yes  No - Are on-site soils consistent with soil parameters used in the fence footing design?
- Yes  No - Does the site show indications of multiple types of soil, and has this been accounted for?
- Yes  No - Is there evidence of landfill areas on site?

### C. Review of Above Grade Water Management with Project Civil Engineer

- Yes  No - Has the surface runoff been accounted for in the site design?
- Yes  No - If storm drains become inoperable where will the water migrate to?
- Yes  No - During renovation of land will temporary drainage be an issue?
- Yes  No - Is the final grading planned to prevent erosion of the base materials under the pile caps (if applicable) and the panel section?

### D. Review of Design Loads and Surcharges

- Yes  No - Has the proper wind or seismic loads been accounted for?
- Yes  No - Is the site exposure consistent with the design requirements?
- Yes  No - During construction are there any temporary surcharges that should be considered?

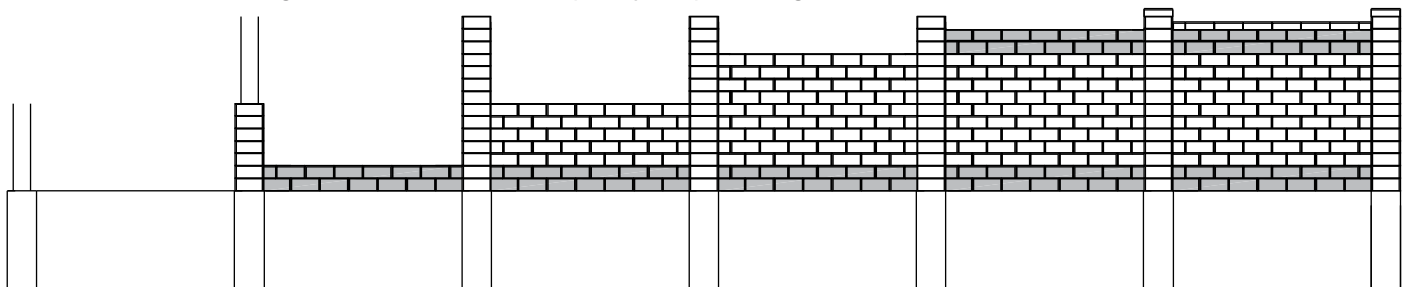

## Construction Inspection:



allanblock.com

### A. Layout and Pile Installation (Check Off)

- \_\_\_\_\_ Verify that the fence layout in both height and length coincide with the current site plan.
- \_\_\_\_\_ Verify that potential surface water is diverted around or properly vented through the fence.
- \_\_\_\_\_ Mark pile locations for fence elevations and changes in fence direction.
- \_\_\_\_\_ Identify changes in fence height.
- \_\_\_\_\_ Determine and locate the proper pile depths and diameters.
- \_\_\_\_\_ Verify that site soils meet the design standards.
- \_\_\_\_\_ Verify that the correct type and color of block has been ordered and delivered to the job site.
- \_\_\_\_\_ Confirm that the proper size and quantity of steel reinforcement, including the steel stirrups located in the horizontal bond beams, have been delivered to the site.
- \_\_\_\_\_ Verify that the layout jigs have been built to the designed fence lengths and are at that job site.
- \_\_\_\_\_ Determine how the concrete will be delivered to the job site for the post footings and the cores of the post block.

### B. Post and Panel Installation

- \_\_\_\_\_ Identify any cracked or damaged block prior to installation and placed aside.
- \_\_\_\_\_ If color variances are noticed in the product, notify the manufacturer to investigate. Do not place any suspect blocks.
- \_\_\_\_\_ Ensure proper shimming is performed to maintain tolerances with respect to the horizontal alignment of the block courses.
- \_\_\_\_\_ Ensure vertical alignment of the fence panel is within tolerances. Vertical alignment should be checked and the panel realigned prior to the installation of additional bond beams, or every four courses.
- \_\_\_\_\_ Ensure that the post blocks are properly centered on the pile / pile cap. If piling alignment is off, make necessary adjustments prior to pilaster construction and commencement with the fence construction.
- \_\_\_\_\_ Ensure that the mortar bed for the placement of the first pilaster block is no thicker than 1 in. (25 mm) thick.
- \_\_\_\_\_ Prior to the pouring of the concrete in the post blocks, ensure that the vertical rebar alignment is set to allow for a minimum 1 in. (25 mm) clear cover between the rebar and the inside of the post block.
- \_\_\_\_\_ Determine whether the bond beams will be pre-cast and delivered to the site or constructed by casting them on-site.
- \_\_\_\_\_ When placing horizontal steel in the bond beams, ensure single lengths are used. Do not splice or butt sections together.
- \_\_\_\_\_ Verify that the proper grout mix consisting of a fine aggregate mix is scheduled for bond beam construction and at the job site.
- \_\_\_\_\_ Ensure by visual inspection that proper consolidation is occurring in the bond beams during grout placement using vibrator.
- \_\_\_\_\_ If pre-casting bond beams, check the bond beam prior to placement for cracks or any other sign of damage that may have occurred during manufacturing, storage or shipping. Discard damaged or cracked bond beams.
- \_\_\_\_\_ Does the panel block overlap the post block a minimum of 1 in. (25 mm) on each end?
- \_\_\_\_\_ Confirm that compaction testing will or will not be required under the fence panels. If it is, who is responsible, at what locations along the fence and what coordination will be required?

### C. Finishing

- \_\_\_\_\_ Confirm if testing is required of the grout (panel / post blocks). How often? Who is doing the testing?
- \_\_\_\_\_ Confirm that the AB Fence Caps have been properly installed and adhered.
- \_\_\_\_\_ Determine what method will be used to verify construction materials, methods, and sequences of construction. (ie: written documentation of as built, full time inspector on-site, photographic documentation)

# Design and Estimating Guide

Charts and design parameters are for estimating purposes only. Actual design parameters and design should come from a local registered engineer. Check with your local Allan Block manufacturer for exact specifications and availability.

The following example, illustrates the use of the AB Fence charts. This fence example is 10 ft. high (3.0 m), requires a panel spacing of approximately 15.3 ft (4.7 m), and is situated in an 80 mph (129 km/h) wind zone UBC 16-1. Using these simple parameters and having a description of the soil will yield an accurate design. A definition of the design parameters is also included here. These charts should be used for estimating quantities for projects which match the site and soil descriptions provided. Consult the Allan Block Engineering Department for details.

Design Estimate Example:		
<b>Fence Length:</b> 610 ft (186 m)	<b>Soil Type:</b> Clay (a soil classified as inorganic, low to medium plasticity)	<b>Seismic Coefficient:</b> 0 (UBC 1997 Fig. 16-2)
<b>Fence Height:</b> 10 ft (3.0 m)	<b>Wind Speed - 50 year return period:</b> 80 mph (129 km/h) (UBC 1997 Fig. 16-1)	<b>Exposure Rating:</b> B

Pile Depth and Maximum Post Spacing		
<b>Wind Speed:</b> 80 mph (129 km/h)		<b>Exposure:</b> B
<b>Soil Type:</b> Clay; Unconstrained Pile, 2.0 ft diameter (0.6 m)		
Fence Height*	Pile Depth	Post Spacing*
7 blocks 4.8 ft 1.5 m	4.0 ft 1.2 m	13 blocks 20.4 ft 6.2 m
9 blocks 6.1 ft 1.9 m	4.0 ft 1.2 m	11 blocks 17.5 ft 5.3 m
12 blocks 8.0 ft 2.4 m	5.0 ft 1.5 m	9.5 blocks 15.3 ft 4.7 m
15 blocks 9.9 ft 3.0 m	6.0 ft 1.8 m	9.5 blocks 15.3 ft 4.7 m

Design Parameters Example:
<b>Fence Height:</b> 15 courses
<b>Post Height:</b> 16 courses
<b>Post Spacing:</b> 9.5 blocks
<b>Number of Panels:</b> 610 ft ÷ 15.3 ft/panel = 40    186 m ÷ 4.7 m/panel = 40
<b>Number of Posts:</b> 41
<b>Pile Diameter:</b> 2.0 ft (0.6 m)
<b>Pile Depth:</b> 6.0 ft (1.8 m)

**Note:** For a detailed material estimate example using hand calculations see the AB Fence Estimating Tech Sheet at [allanblock.com](http://allanblock.com).

\*All dimensions are approximate and will vary by manufacturer.

AB Fence Panel Block Quantity (per each panel)									
AB Fence Panel Length*	Fence Panel Height w/cap*								
	7 courses 4.8 ft (1.5 m)	8 courses 5.4 ft (1.7 m)	9 courses 6.1 ft (1.9 m)	10 courses 6.7 ft (2.0 m)	11 courses 7.3 ft (2.2 m)	12 courses 8.0 ft (2.4 m)	13 courses 8.6 ft (2.6 m)	14 courses 9.3 ft (2.8 m)	15 courses 9.9 ft (3.0 m)
<b>6 blocks</b> 8.8 ft (2.7 m)	39	44	50	55	61	66	72	77	83
<b>7 blocks</b> 10.3 ft (3.1 m)	46	52	59	65	72	78	85	91	98
<b>8 blocks</b> 11.8 ft (3.6 m)	53	60	68	75	83	90	98	105	113
<b>9 blocks</b> 13.2 ft (4.0 m)	60	68	77	85	94	102	111	119	128
<b>10 blocks</b> 14.7 ft (4.5 m)	67	76	86	95	105	114	124	133	143
<b>11 blocks</b> 16.2 ft (4.9 m)	74	84	95	105	116	126	137	144	158
<b>12 blocks</b> 17.6 ft (5.4 m)	81	92	104	115	127	138	150	161	173
<b>13 blocks</b> 19.1 ft (5.8 m)	88	100	113	125	138	150	163	175	188
<b>AB Fence Half Panel Blocks</b>	6	8	8	10	10	12	12	14	14



# Design Tables

The following design tables provide specific structural estimates for different wind loads and soil types. These tables provide an accurate estimate for fence design in non hurricane prone areas. To use these tables follow these simple steps:

- 1) Verify site conditions for wind speed and soil conditions.
- 2) Identify the 50-year average wind speed where your project is located. Reference the Uniform Building Code or Appendix C of the National Building Code of Canada that provides a 1/50 hourly wind pressure that can be used.
- 3) Select a type of exposure based on the following classification:
  - Exposure B: Surface roughness consisting of urban and suburban areas, wooded areas, or other terrain with numerous closely spaced obstructions having the size of a single family dwelling or larger.
  - Exposure C: Surface roughness consisting of open terrain with scattered obstructions having heights generally less than 30 ft (9.1 m) extending ½-mile (805 m) or more from the site. This category includes flat open country, grasslands, and bodies of water under 1-mile (1.6 km) in width.
  - Exposure D: Describes the most severe exposure with surface roughness consisting of flat, unobstructed areas and bodies of water over 1-mile (1.6 km) in width. Exposure D extends inland from the shoreline ¼-mile (0.4 km).
- 4) Match values from steps 2 and 3 to Wind Load table:
- 5) Locate your particular load condition in the following design tables and find the pile depth, maximum post spacing, steel schedule and bond beam design.



<b>Wind Loads</b>			
<b>Exposures</b>	<b>70 MPH</b>	<b>80 MPH</b>	<b>90 MPH</b>
<b>B</b>	<b>B-70</b>	<b>B-80</b>	<b>B-90</b>
<b>C</b>	<b>C-70</b>	<b>C-80</b>	<b>C-90</b>
<b>D</b>	<b>D-70</b>	<b>D-80</b>	<b>D-90</b>

For more information see AB Fence Tech Sheet for Wind Speeds and Pressures at [allanblock.com](http://allanblock.com).



## DESIGN TABLES - Pile Depth based on a 2 ft (0.61 m) diameter.

		Soil Types: Course to medium sands, clean sand and gravel				Soil Types: Uniform to well-graded sands, sandy silts				Soil Types: Uniform to well-graded silts, sandy and silty clays			
Load Height (ft) (m)	Pile Depth* (ft) (m)	Post Spacing	Post/Pile	Bond Beams	Pile Depth*	Post Spacing	Post/Pile	Bond Beams	Bond Beams	Post Spacing	Post/Pile	Bond Beams	Bond Beams
		(ft) (m)	(ft) (m)	(ft) (m)	(ft) (m)	(ft) (m)	(ft) (m)	(ft) (m)	(ft) (m)	(ft) (m)	(ft) (m)	(ft) (m)	(ft) (m)
4	1.22	20.4	4#5	2#4	4.0*	6.22	4#5	2#4	2#10M	4.0*	6.22	4#5	2#4
5	1.50	20.4	4#5	4#15M	4.0	6.22	4#5	2#4	2#10M	4.0	6.22	4#5	2#4
6	1.83	20.4	4#5	4#15M	4.0	6.22	4#5	2#4	2#10M	4.0	6.22	4#5	2#4
7	2.13	19.7	4#5	4#15M	4.0	6.0	4#5	2#4	2#10M	4.0	6.0	4#5	2#4
8	2.44	17.5	4#5	4#15M	4.0	5.33	4#5	2#4	2#10M	4.5	5.33	4#5	2#4
9	2.74	17.5	4#5	4#15M	4.5	5.33	4#5	3#4	3#10M	5.0	5.33	4#5	3#4
10	3.05	17.5	4#5	4#15M	5.0	5.33	4#5	3#4	3#10M	5.5	5.33	4#5	3#4

## C-70

4	1.22	20.4	4#5	4#15M	4.0*	6.22	4#5	2#4	2#10M	4.0*	6.22	4#5	2#4
5	1.50	18.9	4#5	4#15M	4.0	5.76	4#5	2#4	2#10M	4.0	5.76	4#5	2#4
6	1.83	16.8	4#5	4#15M	4.0	5.12	4#5	2#4	2#10M	4.0	5.12	4#5	2#4
7	2.13	16.0	4#5	4#15M	4.0	4.88	4#5	2#4	2#10M	4.5	4.88	4#5	2#4
8	2.44	14.5	4#5	4#15M	4.5	4.42	4#5	2#4	2#10M	5.0	4.42	4#5	2#4
9	2.74	14.5	4#5	4#15M	5.0	4.42	4#5	3#4	3#10M	6.0	4.42	4#5	3#4
10	3.05	14.5	4#5	4#15M	5.5	4.42	4#5	3#4	3#10M	6.5	4.42	4#5	3#4

## D-70

4	1.22	18.2	4#5	4#15M	4.0*	5.55	4#5	2#4	2#10M	4.0*	5.55	4#5	2#4
5	1.50	16.8	4#5	4#15M	4.0	5.12	4#5	2#4	2#10M	4.0	5.12	4#5	2#4
6	1.83	15.2	4#5	4#15M	4.0	4.63	4#5	2#4	2#10M	4.5	4.63	4#5	2#4
7	2.13	14.5	4#5	4#15M	4.5	4.42	4#5	2#4	2#10M	5.0	4.42	4#5	2#4
8	2.44	13.1	4#5	4#15M	5.0	3.99	4#5	2#4	2#10M	5.5	3.99	4#5	2#4
9	2.74	13.1	4#5	4#15M	5.5	3.99	4#5	3#4	3#10M	6.5	3.99	4#5	3#4
10	3.05	13.1	4#5	4#15M	6.0	3.99	4#5	3#4	3#10M	7.0	3.99	4#5	3#4

The above chart is for estimating fence design only. Actual design should come from a qualified engineer. Maximum post spacing is based on block lengths of 17.625 in. (447.68 mm) and 0.5 in (13 mm) tolerance. \* Indicates that the minimum pile depth is per the local engineer's recommendations.

## DESIGN TABLES - Pile Depth based on a 2 ft (0.61 m) diameter.

Load Height (ft) (m)	Soil Types: Course to medium sands, clean sand and gravel				Soil Types: Uniform to well-graded sands, sandy silts				Soil Types: Uniform to well-graded silts, sandy and silty clays			
	Pile Depth* (ft) (m)	Post Spacing (ft) (m)	Post/Pile (ft) (m)	Bond Beams (ft) (m)	Pile Depth* (ft) (m)	Post Spacing (ft) (m)	Post/Pile (ft) (m)	Bond Beams (ft) (m)	Pile Depth* (ft) (m)	Post Spacing (ft) (m)	Post/Pile (ft) (m)	Bond Beams (ft) (m)
4	4.0*	20.4	4#5	2#4	4.0*	20.4	4#5	2#4	4.0*	20.4	4#5	2#4
5	1.50	20.4	4#5	2#4	4.0	20.4	4#5	2#4	4.0	20.4	4#5	2#4
6	1.83	17.5	4#5	2#4	4.0	17.5	4#5	2#4	4.0	17.5	4#5	2#4
7	2.13	16.8	4#5	2#4	4.0	16.8	4#5	2#4	4.5	16.8	4#5	2#4
8	2.44	15.3	4#5	2#4	4.5	15.3	4#5	2#4	5.0	15.3	4#5	2#4
9	2.74	15.3	4#5	3#4	5.0	15.3	4#5	3#4	5.5	15.3	4#5	3#4
10	3.05	15.3	4#5	3#4	5.5	15.3	4#5	3#4	6.0	15.3	4#5	3#4

### C-80

4	1.22	18.2	4#5	2#4	4.0	18.2	4#5	2#4	4.0	18.2	4#5	2#4
5	1.50	16.8	4#5	2#4	4.0	16.8	4#5	2#4	4.0	16.8	4#5	2#4
6	1.83	14.5	4#5	2#4	4.0	14.5	4#5	2#4	4.5	13.7	4#5	2#4
7	2.13	13.8	4#5	2#4	4.5	13.8	4#5	2#4	5.0	13.8	4#5	2#4
8	2.44	13.1	4#5	2#4	5.0	13.1	4#5	2#4	6.0	13.1	4#5	2#4
9	2.74	13.1	4#5	3#4	5.5	13.1	4#5	3#4	6.5	13.1	4#5	3#4
10	3.05	13.1	4#5	3#4	6.0	13.1	4#5	3#4	7.0	13.1	4#5	3#4

### D-80

4	1.22	16.0	4#5	2#4	4.0	16.0	4#5	2#4	4.0	16.0	4#5	2#4
5	1.50	14.5	4#5	2#4	4.0	14.5	4#5	2#4	4.5	13.7	4#5	2#4
6	1.83	13.1	4#5	2#4	4.5	13.1	4#5	2#4	5.0	13.1	4#5	2#4
7	2.13	12.4	4#5	2#4	5.0	12.4	4#5	2#4	5.5	12.4	4#5	2#4
8	2.44	11.6	4#5	2#4	5.5	11.6	4#5	2#4	6.5	11.6	4#5	2#4
9	2.74	11.6	4#5	3#4	6.0	11.6	4#5	3#4	7.0	11.6	4#5	3#4
10	3.05	11.6	4#5	3#4	6.5	11.6	4#5	3#4	7.5	11.6	4#5	3#4

The above chart is for estimating fence design only. Actual design should come from a qualified engineer. Maximum post spacing is based on block lengths of 17.625 in. (447.68 mm) and 0.5 in (13 mm) tolerance. \* Indicates that the minimum pile depth is per the local engineer's recommendations.

## DESIGN TABLES - Pile Depth based on a 2 ft (0.61 m) diameter.

Load Height (ft) (m)	Soil Types: Course to medium sands, clean sand and gravel				Soil Types: Uniform to well-graded sands, sandy silts				Soil Types: Uniform to well-graded silts, sandy and silty clays			
	Pile Depth (ft) (m)	Post Spacing (ft) (m)	Post/Pile Steel (ft) (m)	Bond Beams (ft) (m)	Pile Depth (ft) (m)	Post Spacing (ft) (m)	Post/Pile Steel (ft) (m)	Bond Beams (ft) (m)	Pile Depth (ft) (m)	Post Spacing (ft) (m)	Post/Pile Steel (ft) (m)	Bond Beams (ft) (m)
4	1.22	19.0	4#5	2#4	4.0	19.0	4#5	2#4	4.0	19.0	4#5	2#4
5	1.50	17.5	4#5	2#4	4.0	17.5	4#5	2#4	4.0	17.5	4#5	2#4
6	1.83	15.2	4#5	2#4	4.0	15.2	4#5	2#4	4.0	15.2	4#5	2#4
7	2.13	14.5	4#5	2#4	4.5	14.5	4#5	2#4	4.5	14.5	4#5	2#4
8	2.44	13.8	4#5	2#4	5.0	13.8	4#5	2#4	5.0	13.8	4#5	2#4
9	2.74	13.8	4#5	3#4	5.5	13.8	4#5	3#4	6.0	13.8	4#5	3#4
10	3.05	13.8	4#5	3#4	6.0	13.8	4#5	3#4	6.5	13.8	4#5	3#4

## C-90

4	1.22	16.0	4#5	2#4	4.0	16.0	4#5	2#4	4.0	16.0	4#5	2#4
5	1.50	14.5	4#5	2#4	4.0	14.5	4#5	2#4	4.5	14.5	4#5	2#4
6	1.83	13.1	4#5	2#4	4.5	13.1	4#5	2#4	5.0	13.1	4#5	2#4
7	2.13	12.4	4#5	2#4	5.0	12.4	4#5	2#4	5.5	12.4	4#5	2#4
8	2.44	10.9	4#5	2#4	5.5	10.9	4#5	2#4	6.0	10.9	4#5	2#4
9	2.74	10.9	4#5	3#4	6.0	10.9	4#5	3#4	7.0	10.9	4#5	3#4
10	3.05	10.9	4#5	3#4	6.5	10.9	4#5	3#4	7.5	10.9	4#5	3#4

## D-90

4	1.22	13.8	4#5	2#4	4.0	13.8	4#5	2#4	4.5	13.8	4#5	2#4
5	1.50	13.1	4#5	2#4	4.5	13.1	4#5	2#4	5.0	13.1	4#5	2#4
6	1.83	11.6	4#5	2#4	5.0	11.6	4#5	2#4	5.5	11.6	4#5	2#4
7	2.13	10.9	4#5	2#4	5.0	10.9	4#5	2#4	6.0	10.9	4#5	2#4
8	2.44	10.1	4#5	2#4	6.0	10.1	4#5	2#4	7.0	10.1	4#5	2#4
9	2.74	10.1	4#5	3#4	6.5	10.1	4#5	3#4	7.5	10.1	4#5	3#4
10	3.05	10.1	4#5	3#4	7.0	10.1	4#5	3#4	8.0	10.1	4#5	3#4

The above chart is for estimating fence design only. Actual design should come from a qualified engineer. Maximum post spacing is based on block lengths of 17625 in. (447.68 mm) and 0.5 in (13 mm) tolerance.

## Site Solutions

Allan Block's extensive engineering provides the capability to meet a broad variety of applications. From security fences and sound barriers with AB Fence to industrial, transportation and residential applications with the Allan Block retaining wall products, Allan Block can meet your needs. It's cost effective, long term performance makes it the product of choice for projects around the world. Allan Block products can be designed to accommodate the toughest federal, state and provincial specifications including applicable AASHTO FHWA and international specifications.

Allan Block has conducted the only full-scale seismic research for segmental retaining walls. The flexible nature and performance of the AB System astounded the experts. Results from these independent tests have been adopted by the National Concrete Masonry Assoc. (NCMA) and other design associations.

You can feel secure in knowing your Allan Block solution can withstand the test of time.





[allanblock.com](http://allanblock.com)

## Allan Blocks Other Products

Allan Block's retaining wall and patio wall products have different styles and looks to suit any project. From beautiful patterned walls or the clean look of one block shape to our Green, Natural and Friendly AB Fieldstone product, that's made with recycled material, we have unlimited possibilities.

To find the most up-to-date information, visit our website at [allanblock.com](http://allanblock.com)





# AB Fence®

AB Fence is a two-sided fencing system that is the perfect product for any project. Its versatile and structurally sound with a striking look that adds great curb appeal. Use it to hide or surround unsightly elements, to block sound from industrial areas, to add screening within neighborhoods, or add security with gated entryways, the list goes on and on.



[allanblock.com](http://allanblock.com)

Use our website at [allanblock.com](http://allanblock.com) for everything you need to help you get started with your AB Fence project today.

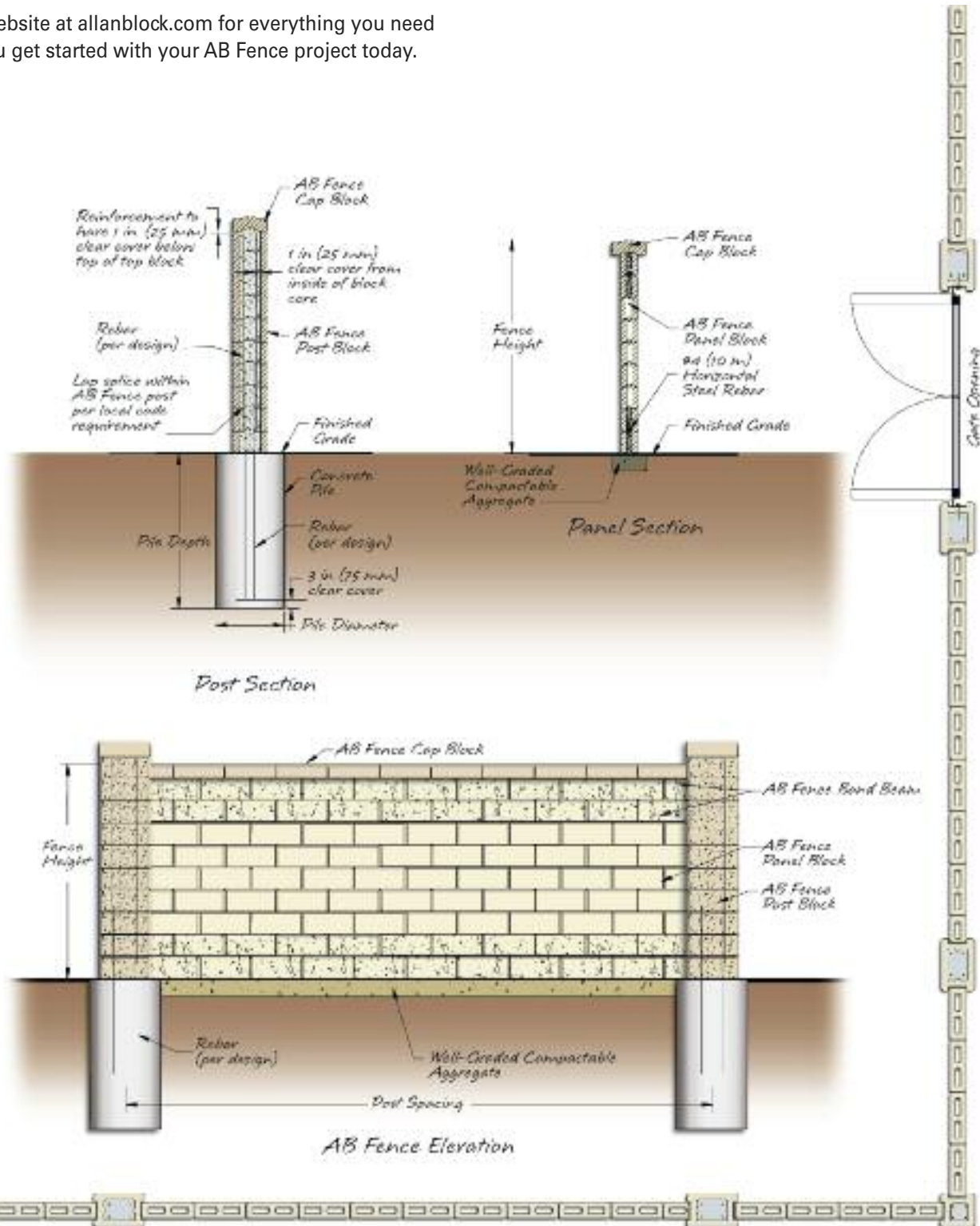

The information and product applications illustrated in this manual have been carefully compiled by the Allan Block Corporation and, to the best of our knowledge, accurately represent Allan Block product use. Final determination of the suitability of any information or material for the use contemplated and its manner of use is the sole responsibility of the user. Structural design analysis shall be performed by a qualified engineer.

Visit [allanblock.com](http://allanblock.com) to see  
all of our available products.



When you purchase Allan Block, you can feel confident that the Allan Block family of products have been created and engineered to deliver complete landscape solutions.



[allanblock.com](http://allanblock.com)



Printed on Paper with  
10% Recycled Fiber